

BM, BMhp

Booster modules
50/60 Hz

DYSTRYBUTOR
Valmark Sp. z o.o.
tel: (22) 868 58 58
mail: biuro@valmark.pl



1. Performance ranges	3	7. Order data, 60 Hz	42
BM, 50 Hz	3	BM 4" (with straight pipe)	42
BM, 60 Hz	3	BM 4" (with elbow)	43
BMhp, 50 Hz	4	BM 6" (with straight pipe)	44
BMhp, 60 Hz	4	BM 8" (with straight pipe)	45
EuP ready	5		
2. General description, BM	6	8. General description, BMhp	46
Applications	6	Applications	46
Standard pumps	6	Standard pumps	46
Pumped liquids	6	Pumped liquids	46
Construction	6	Construction	46
Motor	6	Motor	46
Operating conditions	7	Operating conditions	47
Types and versions	8	Types and versions	48
Sectional drawings	8	Sectional drawings	48
3. Technical data	9	9. Performance curves, 50 Hz	49
Material specification	9	BMhp 17	49
Type key	11	BMhp 30	50
Installation	11	BMhp 46	51
Connections	11	BMhp 60	52
Limitations to operation	12	BMhp 77	53
Automatic control devices	12	BMhp 95	54
Checking of operation	12	BMhp 125	55
Performance data	13	BMhp 160	56
		BMhp 215	57
4. Performance curves, 50 Hz	14	10. Order data, 50 Hz	58
BM 3A	14	BMhp 6" (with straight pipe)	58
BM 5A	15	BMhp 8" (with straight pipe)	59
BM 9	16		
BM 17	17	11. Performance curves, 60 Hz	60
BM 30	18	BMhp 17	60
BM 46	19	BMhp 30	61
BM 60	20	BMhp 46	62
BM 77	21	BMhp 60	63
BM 95	22	BMhp 77	64
BM 125	23	BMhp 95	65
BM 160	24	BMhp 125	66
BM 215	25	BMhp 160	67
		BMhp 215	68
5. Order data, 50 Hz	26	12. Order data, 60 Hz	69
BM 4" (with straight pipe)	26	BMhp 6" (with straight pipe)	69
BM 4" (with elbow)	27	BMhp 8" (with straight pipe)	70
BM 6" (with straight pipe)	28		
BM 8" (with straight pipe)	29	13. Accessories	71
6. Performance curves, 60 Hz	30	CUE frequency converter	71
BM 3A	30	MP 204 motor protector	74
BM 5A	31	G100 gateway	76
BM 9	32	BM 4"	78
BM 17	33	BM 6"	79
BM 30	34	BM 8"	79
BM 46	35	BMhp	79
BM 60	36		
BM 77	37	14. Customising your pump	80
BM 95	38	Custom-made pumps	80
BM 125	39		
BM 160	40	15. Grundfos Product Center	81
BM 215	41		

1. Performance ranges

BM, 50 Hz

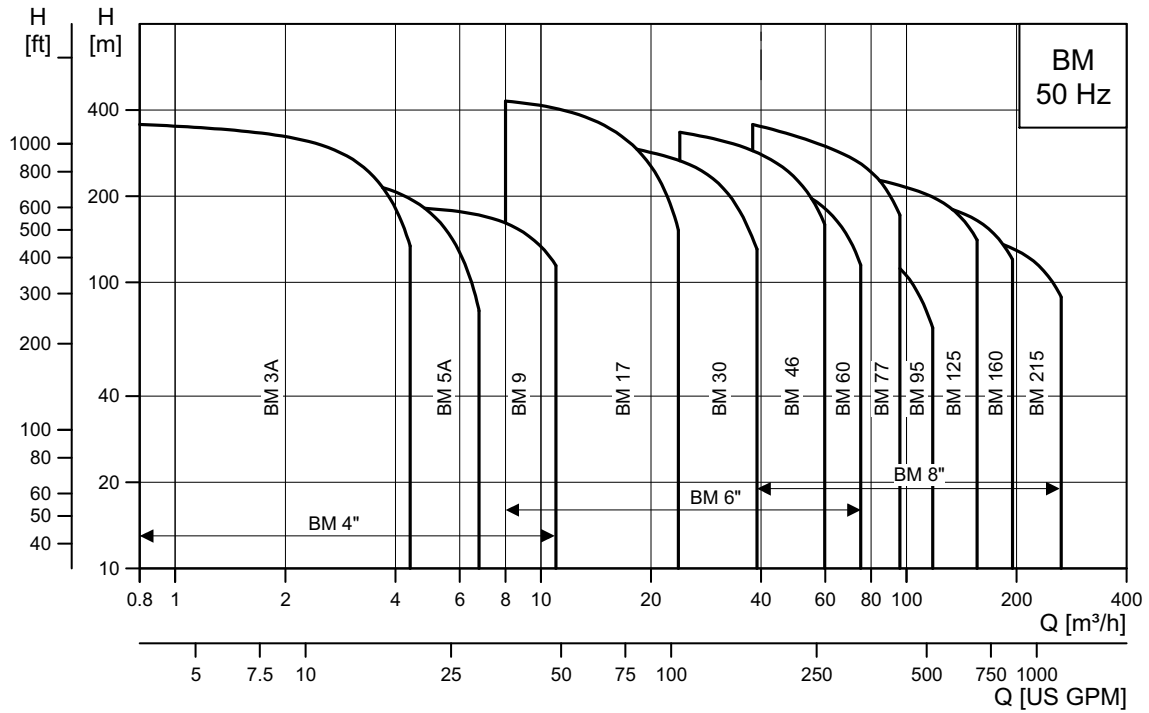

TM01 1230 0215

Fig. 1 Performance range, BM 50 Hz

BM, 60 Hz

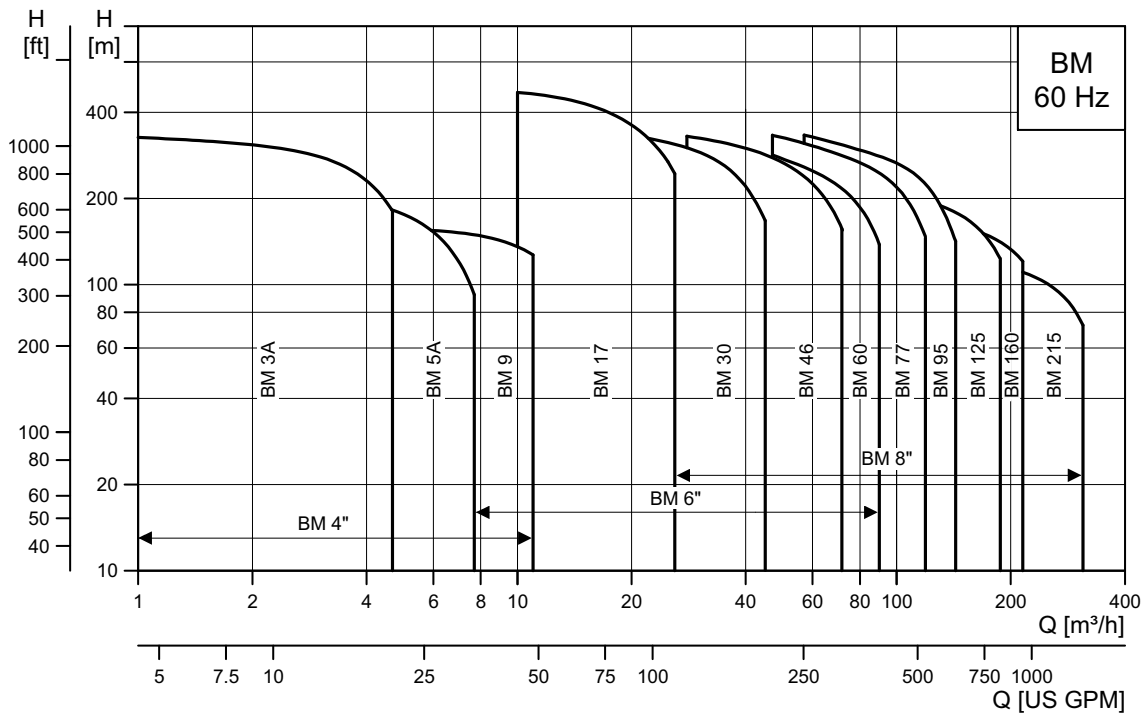

TM01 1232 0215

Fig. 2 Performance range, BM 60 Hz

BMhp, 50 Hz

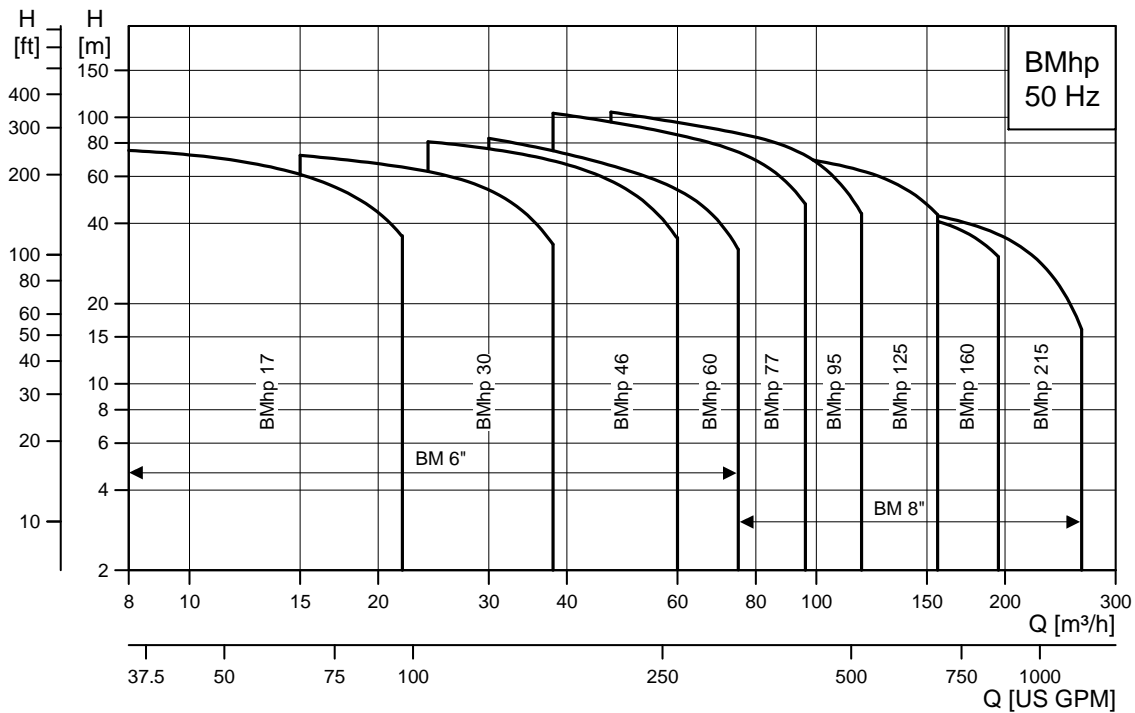

Fig. 3 Performance range, BMhp 50 Hz

TM04 7973 3712

BMhp, 60 Hz

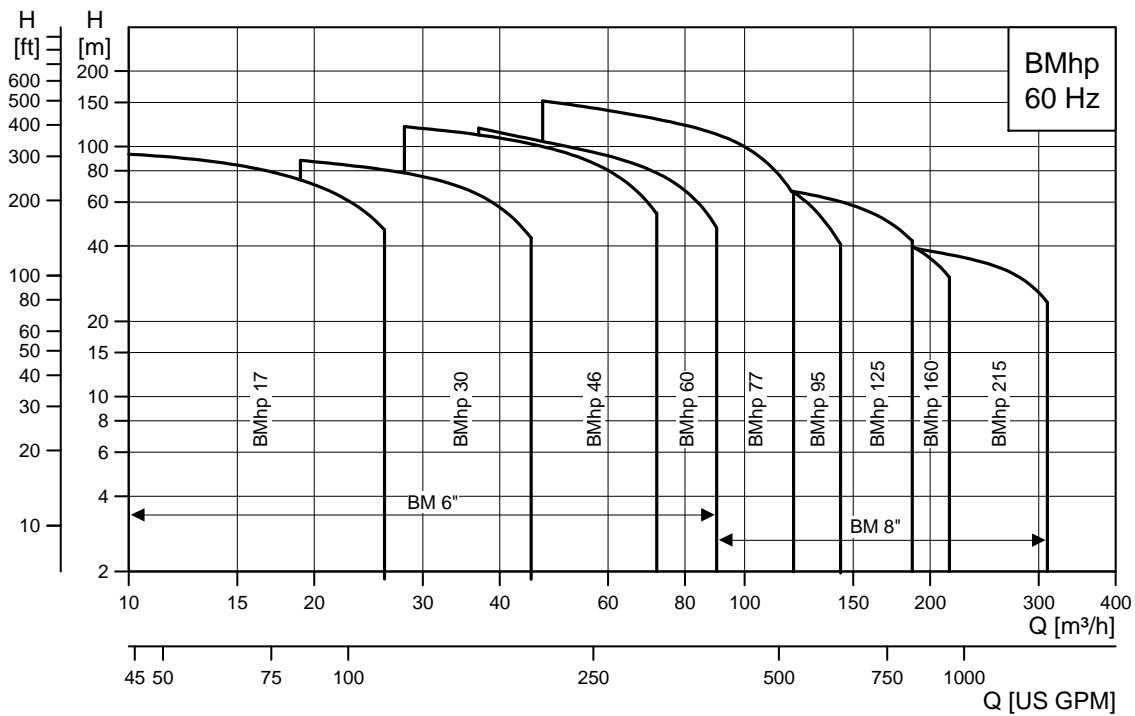

Fig. 4 Performance range, BMhp 60 Hz

TM04 7974 3712

EuP ready

The BM, BMhp pumps are energy-optimised and comply with the EuP Directive (Commission Regulation (EC) No 547/2012) which will be effective as from 1 January 2013. As from this date, all pumps will be classified/graduated in a new energy efficiency index (MEI).



MEI index

Minimum Efficiency Index (MEI) is the dimensionless scale unit for hydraulic pump efficiency at best efficiency point, part load and overload.

EU regulations set efficiency requirements to $MEI \geq 0.1$ as from 1 January 2013 and $MEI \geq 0.4$ as from 1 January 2015. An indicative benchmark for the best-performing water pumps available on the market in 2012 is $MEI \geq 0.70$.

Efficiency and MEI index

Pump type	Efficiency [%]	MEI
BM 3A-9	58	≥ 0.80
BM 5A -12	60	≥ 0.56
BM 9	71	≥ 0.70
BM 17-9	74	≥ 0.76
BM 30-9	75	≥ 0.50
BM 46-9	76	≥ 0.50
BM 60-9	77	≥ 0.60
BM 77-9	78	≥ 0.44
BM 95-9	79	≥ 0.50
BM 125-9	79	≥ 0.37
BM 160-9	80	≥ 0.39
BM 215-9	83	≥ 0.46

For more information about the new energy directive and MEI index please visit:
energy.grundfos.com
europump.eu/efficiencycharts

2. General description, BM

Applications

The Grundfos BM booster module is suitable for industrial and water supply applications requiring increased system pressure.

The BM booster module is the optimum solution for applications requiring the following:

- sealless pumps
- pumps capable of coping with high system pressures
- high heads
- quiet operation
- a minimum of maintenance.

Typical applications

BM booster modules are suitable for the following typical applications:

- water treatment such as:
 - reverse osmosis in domestic water supply systems
 - hospitals, laboratories as well as chemical, electronics and metal industries
 - ultra-filtration in chemical and galvanic industries
 - painting workshops, metal and mineral industries
- liquid transfer
- pressure boosting
- closed circulation systems with a high static pressure.

Standard pumps

The following standard pumps are available for the BM booster modules:

- SP 3A, SP 5A and SP 9 in 4" sleeve
- SP 17, SP 30, SP 46 and SP 60 in 6" sleeve
- SP 30, SP 46, SP 60, SP 77, SP 95, SP 125, SP 160 and SP 215 in 8" sleeve.

Note: The BM booster modules are supplied without non-return valves.

Pumped liquids

Thin, non-explosive liquids not containing abrasive particles or fibres. The liquid must not attack the pump materials chemically or mechanically.

If the density and/or viscosity of the pumped liquid is higher than that of water, it may be necessary to use motors with a higher output than the standard output stated.

Construction

Modified standard submersible pumps are used for the BM booster modules. Pump and motor are centred in the stainless-steel sleeve.

Both sleeve ends can be connected to the piping by means of Victaulic couplings.

A terminal box for electrical connection is located at the discharge end.

The sleeve of BM 4", 6" and 8" modules is supplied with straight pipe inlet and outlet.

BM 4" modules are also available with 90 ° bends at the suction and discharge ends.

Motor

Asynchronous submersible squirrel-cage motor of the canned type with water-lubricated bearings.

Voltages

- 3 x 380-415 V - 10 %/+ 6 %
- 3 x 440-480 V - 10 %/+ 6 %.

Enclosure class

- IP58 (MS 4000, MMS 8000)
- IP68 (MS 6000).

Insulation class

MMS wet-wound with PE/PA winding wires.

Special versions

Voltages up to 1000 V available on request.

Operating conditions

Flow rate

- 50 Hz: Max. 265 m³/h, 1166 US gpm
- 60 Hz: Max. 310 m³/h, 1364 US gpm.

Temperature

Max. 40 °C / 104 °F.

Contact Grundfos in case of higher temperature.

Outlet pressure

Max. 80 bar / 1160 psi.

Recommended inlet pressure at 25 °C / 77 °F

BM	Min.		Max.	
	[bar]	[psi]	[bar]	[psi]
4"	0.5	7.25	60	870
6"	0.5	7.25	50*	725*
8"	1	14.5	25*	363*

* 60 bar / 870 psi on request.

Rated speed

- 50 Hz: 2870 min⁻¹
- 60 Hz: 3450 min⁻¹.

Sound pressure level

- The sound pressure level of BM 4" and 6" booster modules is below 70 dB(A).
- The sound pressure level of BM 8" booster modules is below 80 dB(A).

See also section *Limitations to operation*, page 12.

Types and versions

BM 4" (with straight pipe)

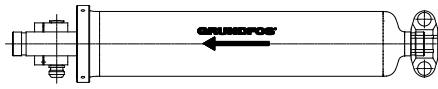

TM00 3793 3598

BM 6"

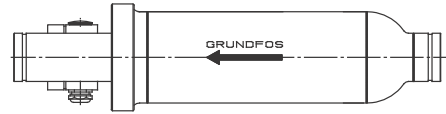

TM00 4019 2410

BM 4" (with elbow)

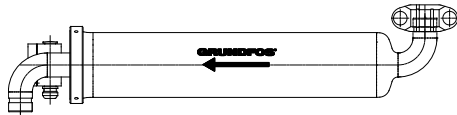

TM00 3794 3598

BM 8"

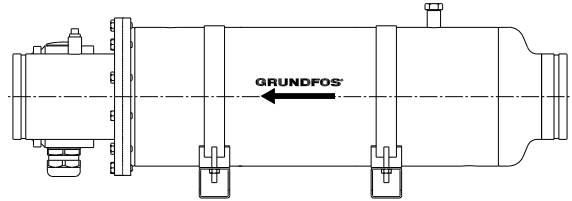

TM01 1420 1912

Sectional drawings

BM 4"

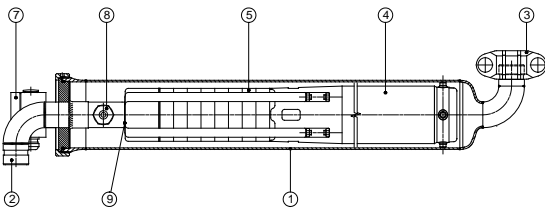

TM00 3795 3598

BM 6"

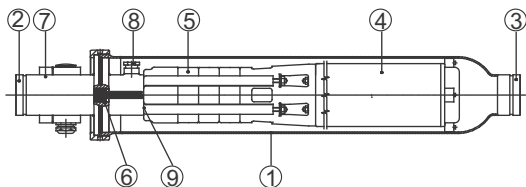

TM00 3796 2410

BM 8"

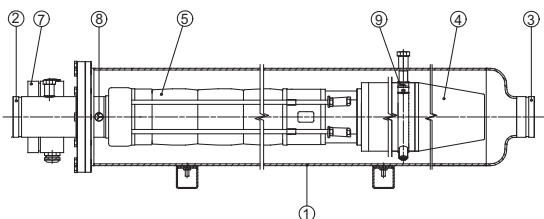

TM01 1419 1912

1. Sleeve
2. Discharge connection
3. Suction connection
4. Submersible motor
5. Submersible pump
6. Cable inlet
7. Terminal box
8. Inlet bypass valve
9. Locking system for BM 8".
BM 4" and BM 6" have a left-hand thread for locking.

3. Technical data

Material specification

Pos.	Component	Materials	1.4301		N version		R version	
			DIN	AISI	DIN	AISI	DIN	AISI
3	Valve seat	Stainless steel/ NBR	1.4301	304	1.4401	316	1.4539	904L
4	Top chamber	Stainless steel	1.4301	304	1.4401	316	1.4539	904L
6 6b	Top bearing Bottom bearing	Stainless steel/ NBR	1.4301	304	1.4401	316	1.4539	904L
7	Neck ring	NBR/PPS	-	-	-	-	-	-
8	Intermediate bearing	NBR	-	-	-	-	-	-
8a	Spacing washer for stop ring	Carbon/graphite, PTFE	-	-	-	-	-	904L
8b	Stop ring	Stainless steel	1.4301	304	1.4401	316	1.4539	904L
9	Chamber	Stainless steel	1.4301	304	1.4401	316	1.4539	904L
10	Bottom chamber with stop ring	Stainless steel	1.4301	304	1.4401	316	1.4539	904L
11	Nut for split cone	Stainless steel	1.4301	304	1.4401	316	1.4539	904L
11c	Nut for stop ring	Stainless steel	1.4301	304	1.4401	316	1.4539	904L
12	Split cone	Stainless steel	1.4301	304	1.4401	316	1.4539	904L
13	Impeller	Stainless steel	1.4301	304	1.4401	316	1.4539	904L
14	Suction interconnector	Stainless steel	1.4301	304	1.4401	316	1.4539	904L
15	Strainer	Stainless steel	1.4301	304	1.4401	316	1.4539	904L
16	Shaft	Stainless steel	1.4462	SAF 2205	1.4460	329	1.4462	SAF 2205
17	Strap	Stainless steel	1.4301	304	1.4401	316	1.4539	904L
19	Nut for strap	Stainless steel	1.4301	304	1.4401	316	1.4539	904L
24	Coupling	Stainless steel	1.4401	316	1.4460	329	1.4462	SAF 2205
72	Wear ring	Stainless steel	1.4301	304	1.4401	316	1.4539	904L
73	Sleeve	Stainless steel	1.4301	304	1.4401	316	1.4462	SAF 2205

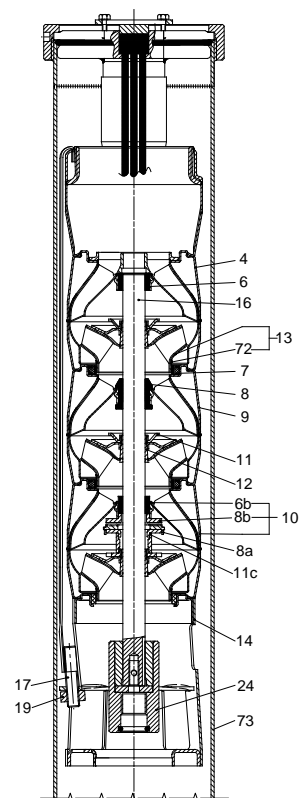

Fig. 5 Example, BM 46

TM01 1520 4997

Pos.	Component	Materials	1.4301		N version		R version	
			DIN	AISI	DIN	AISI	DIN	AISI
MS 4000 / MS 6000								
1	Shaft	Stainless steel	1.4057	304	1.4462	SAF 2205	1.4462	SAF 2205
2	Shaft seal	Tungsten carbide/ceramic	-	-	-	-	-	-
3	Motor sleeve	Stainless steel	1.4301	304	1.4539	904L	1.4539	904L
4	Motor end shield	Stainless steel	1.4301	304	1.4539	904L	1.4539	904L
5	Radial bearing	Ceramic/tungsten carbide	-	-	-	-	-	-
6	Thrust bearing	Ceramic/carbon	-	-	-	-	-	-
	Rubber parts	NBR/Buna N	-	-	-	-	-	-
MMS 8000								
1	Shaft	Stainless steel	1.4460	329	1.4460	329	1.4462	SAF 2205
2	Shaft seal	Tungsten carbide/ceramic	-	-	-	-	-	-
3	Motor sleeve	Stainless steel	1.4401	316	1.4401	316	1.4539	904L
4	Motor end shield	BM: Cast iron BM-N(E): Stainless steel	EN- JL1040	-	1.4401	316	1.4539	904L
5	Radial bearing	Ceramic/tungsten carbide	-	-	-	-	-	-
6	Thrust bearing	Ceramic/carbon	-	-	-	-	-	-
	Rubber parts	NBR/Buna N	-	-	-	-	-	-

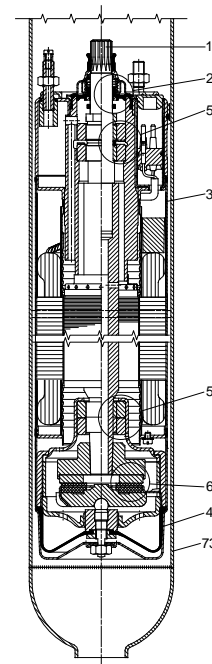

Fig. 6 Example, MS 4000

TM01 1522 4997

Type key

Example	BM 3 (A) 24 A N E R		
Booster module			
Rated pump flow rate [m ³ /h]			
Generation			
Number of stages			
Reduced impeller			
Materials			
BM 4"	Sleeve	Pump	Motor
1.4301	1.4301/304	1.4301/304	1.4301/304
N	1.4401/316	1.4401/316	1.4539/904L
NE	1.4401/316	1.4401/316	1.4539/904L
R	1.4539/904L	1.4539/904L	1.4539/904L
BM 6"			
1.4301	1.4301/304	1.4301/304	1.4301/304
N	1.4401/316	1.4401/316	1.4539/904L
NE	1.4401/316	1.4401/316	1.4539/904L
R	1.4462/SAF 2205	1.4539/904L	1.4539/904L
BM 8"			
1.4301	1.4301/304	1.4301/304	1.4301/304
N	1.4401/316	1.4401/316	1.4401/316
NE	1.4401/316	1.4401/316	1.4401/316
R	1.4462/SAF 2205	1.4539/904L	1.4539/904L

NE: Pump rubber parts in FKM.

Installation

Modules connected in series and in parallel

Symbols used in figures 7 to 10.

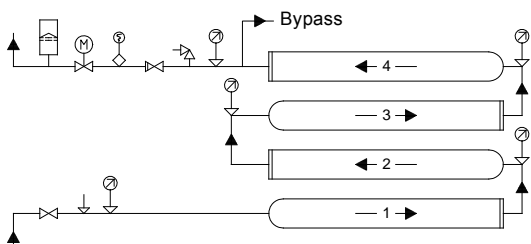
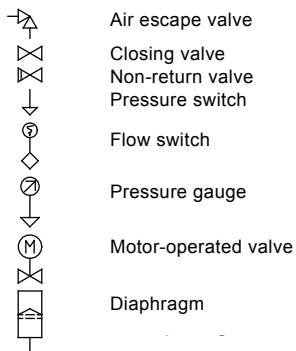

Fig. 7 Booster unit with four modules connected in series, mounted above each other

TM00 3764 1094

TM00 3760 1094

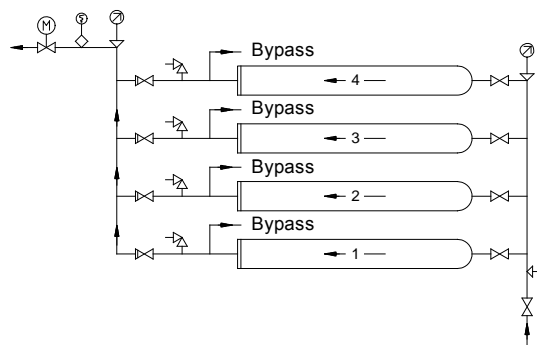

Fig. 8 Booster unit with four modules connected in parallel, mounted above each other

TM00 3761 1094

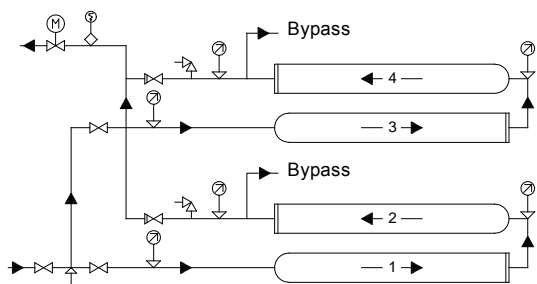

Fig. 9 Booster unit with two modules connected in series and in parallel, mounted above each other

TM00 3762 1094

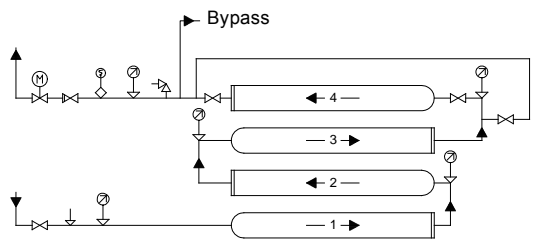

Fig. 10 Booster unit with four modules connected in series with bypass, mounted above each other

TM00 3763 1094

Connections

Size	Type	Victaulic coupling, style 77
BM 4"	BM 3A - BM 9	1 1/4" / Ø42
BM 6"	BM 17 - BM 60	3" / Ø89
BM 8"	BM 30 - BM 46	3" / Ø89
BM 8"	BM 60	4" / Ø114
BM 8"	BM 77 - BM 95	5" / Ø139
BM 8"	BM 125 - BM 215	6" / Ø168

Limitations to operation

The capacity of the modules should always be kept within the recommended flow rate and pressure range of each individual pump.

Recommended flow rate at 25 °C / 77 °F				
Type	[m ³ /h]		US [gpm]	
	50 Hz	60 Hz	50 Hz	60 Hz
BM 3A	0.8 - 4.4	1.0 - 4.7	3.5 - 20	4.4 - 21
BM 5A	2.5 - 6.8	3.0 - 7.7	11-30	13-34
BM 9	4.0 - 11	4.8 - 11	17-48	21-48
BM / BMhp 17	8-22	10-26	35-176	44-115
BM / BMhp 30	15-38	19-45	66-167	84-198
BM / BMhp 46	24-60	28-72	106-264	123-317
BM / BMhp 60	30-75	37-90	132-330	163-396
BM / BMhp 77	38-96	47-120	167-422	207-528
BM / BMhp 95	47-118	57-143	207-520	251-629
BM / BMhp 125	62-156	75-187	273-686	330-823
BM / BMhp 160	78-195	90-215	343-858	396-946
BM / BMhp 215	98-265	115-310	431-1166	506-1364

Recommended pressure					
Type	Inlet pressure		Outlet pressure		
	Min.		Max.*		Max.*
	[bar]	[psi]	[bar]	[psi]	[psi]
BM 4"	0.5	7.25	60	870	1160
BM 6"	0.5	7.25	50	725	1160
BM 8"	1	14.5	25	362	1015
BMhp 6"	0.5	7.25	80	725	1160
BMhp 8"	1	14.5	80	362	1015

* **Note:** If the maximum inlet/outlet pressure is exceeded, a safety valve should be installed.

Maximum permissible liquid temperature			
Motor	Max. liquid temperature	Min. flow velocity past the motor	Min. flow rate
	[°C]	[m/s]	[m ³ /h]
Grundfos 4"	40	0.15	0.8
Grundfos 6"	30	0.15	5.5
Grundfos 8"	40	0.15	18.5

Automatic control devices

To protect the pumps against dry running and to ensure a minimum flow of cooling water past the motors, the system must be fitted with flow and pressure control devices.

A pressure switch on the suction side is sized in accordance with the estimated inlet pressure. At a pressure lower than 0.5 bar / 7.25 psi for BM 4" and BM 6", and 1 bar / 14.5 psi for BM 8", an alarm is given and shortly after the pumps will stop (max. 15 sec.).

All discharge connections to the system should be fitted with flow switches which will stop the system at the set minimum flows.

The above control devices ensure a correct inlet pressure and a minimum flow of cooling water past the motor.

Flow switch cutting-in is adjusted for a minimum time delay equivalent to the maximum starting frequency of the system.

Checking of operation

Depending on the number of operating hours of the pumps, the following should be checked at suitable intervals:

- flow
- starting frequency
- control and protective devices
- liquid temperature
- minimum flow through modules during operation.

Performance data

Curve conditions

The guidelines below apply to the curves on the following pages.

- The curves apply to actual speeds at 50 Hz or 60 Hz.
The bold curves indicate the permissible duty range.
The thin curves are only intended as a guide.
All curves are based on average values according to ISO 9906 Annex A.
If a minimum performance is required, individual measurements must be carried out.
The curves apply to a kinematic viscosity of $1 \text{ mm}^2/\text{s}$ (1 cSt).
The power curve P2/hp shows pump power input per stage.
The efficiency curve η shows pump efficiency, i.e. pump without motor.
The performance tests have been made at a water temperature of $20 \text{ }^\circ\text{C}$.
Test liquid: airless water.
- The conversion between head H (m) and pressure p (kPa) has been made for water with a density of $\rho = 1000 \text{ kg/m}^3$. If the density differs from this value, the created pressure will be proportional to the density.

Series operation (high pressure)

If a pressure higher than that of a single module is required, several modules are connected in series. The resulting pressure is found by adding the pressure of each individual module. The flow rate will be the same as for one pump.

Note: Make sure that the maximum inlet pressure is not exceeded. See section *Operating conditions*, on page 7.

Parallel operation (high flow)

If a flow higher than that of a single module is required, several modules are connected in parallel. The resulting flow is found by adding the flow of each individual module. The pressure will be the same as for one pump.

4. Performance curves, 50 Hz

BM 3A

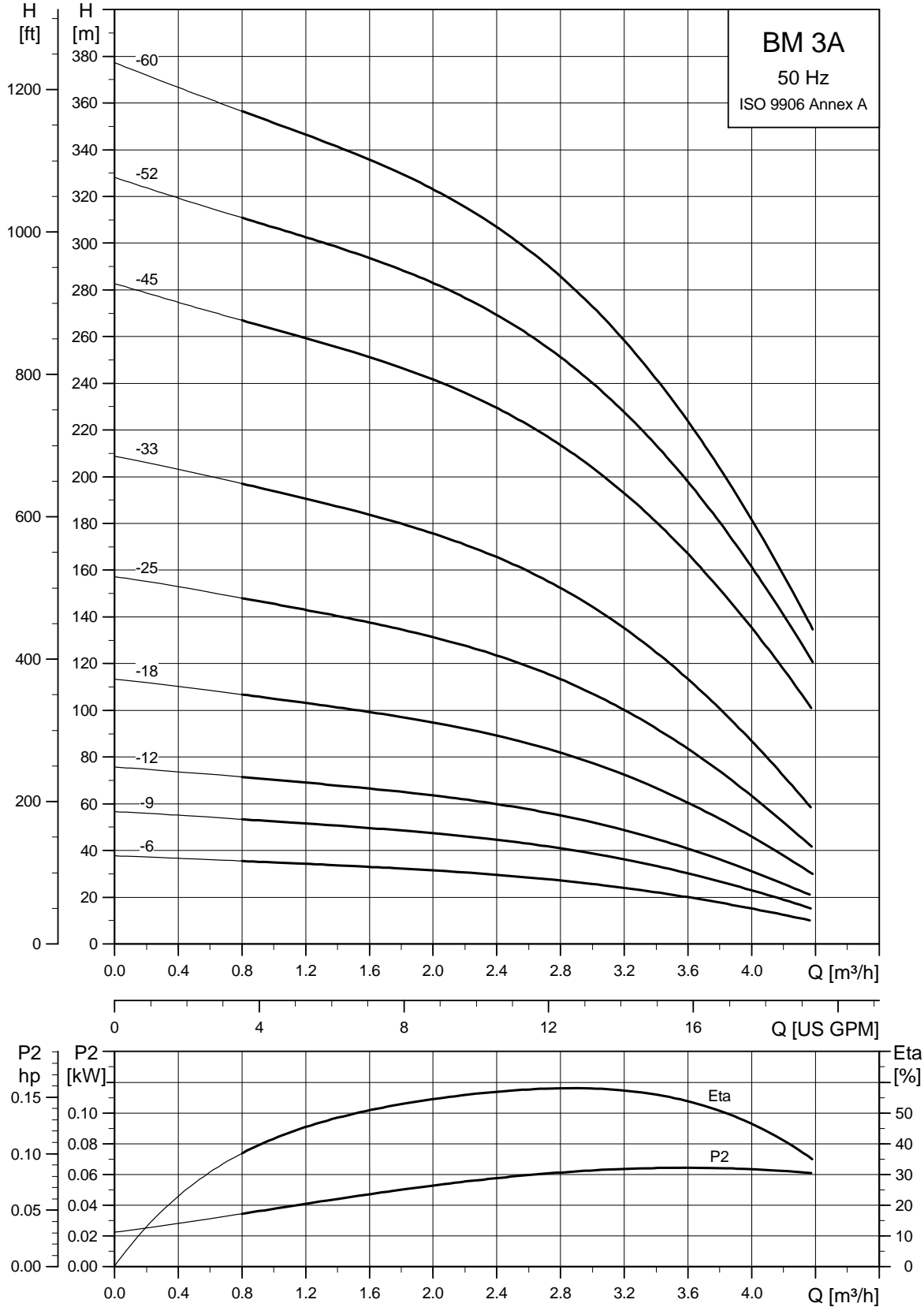

TM01 1212 3400

BM 5A

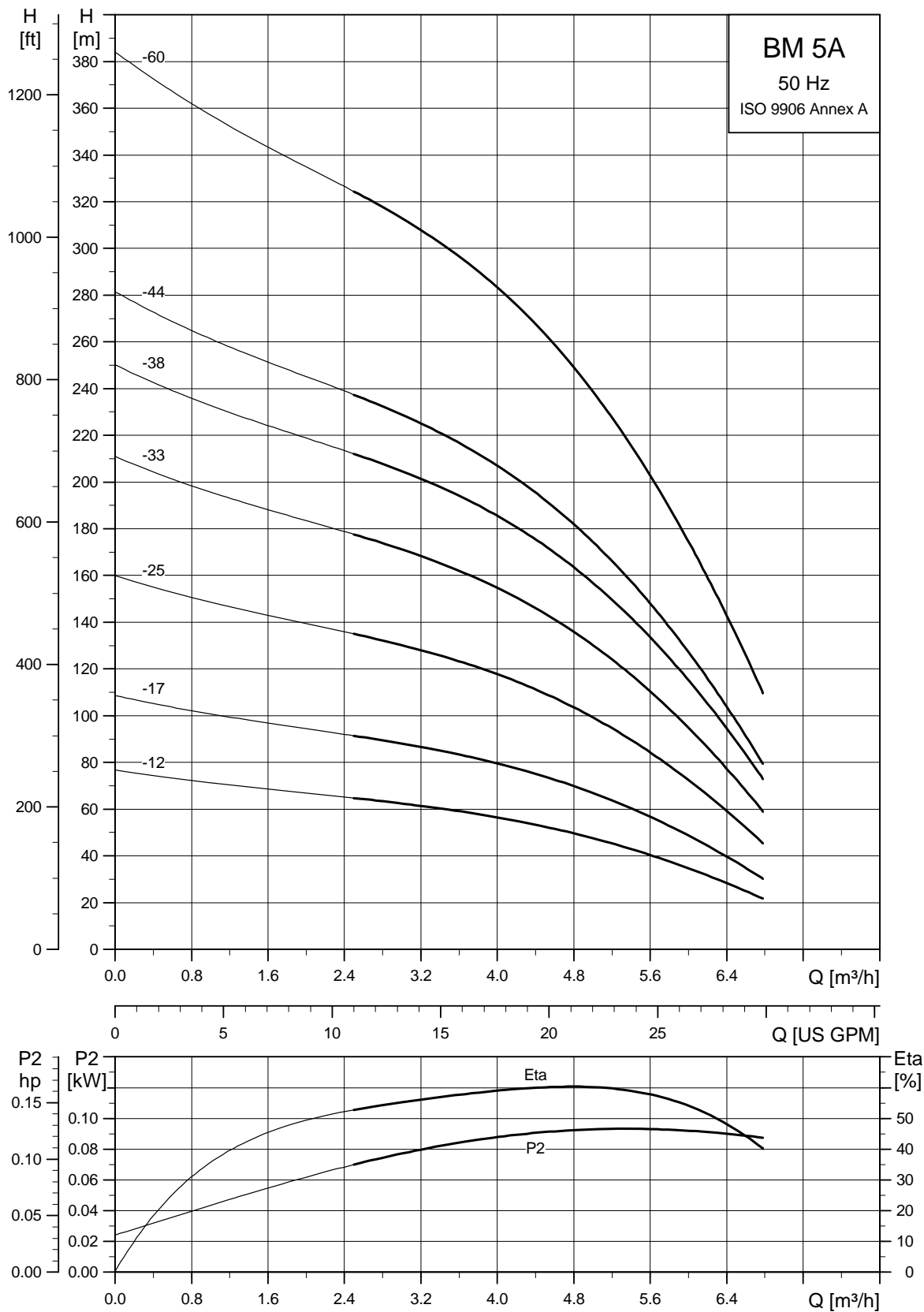

TM01 1213 3400

BM 9

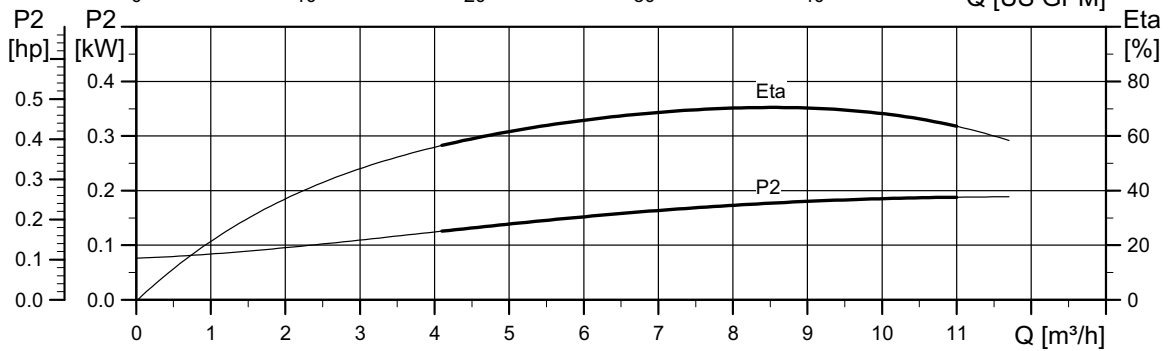
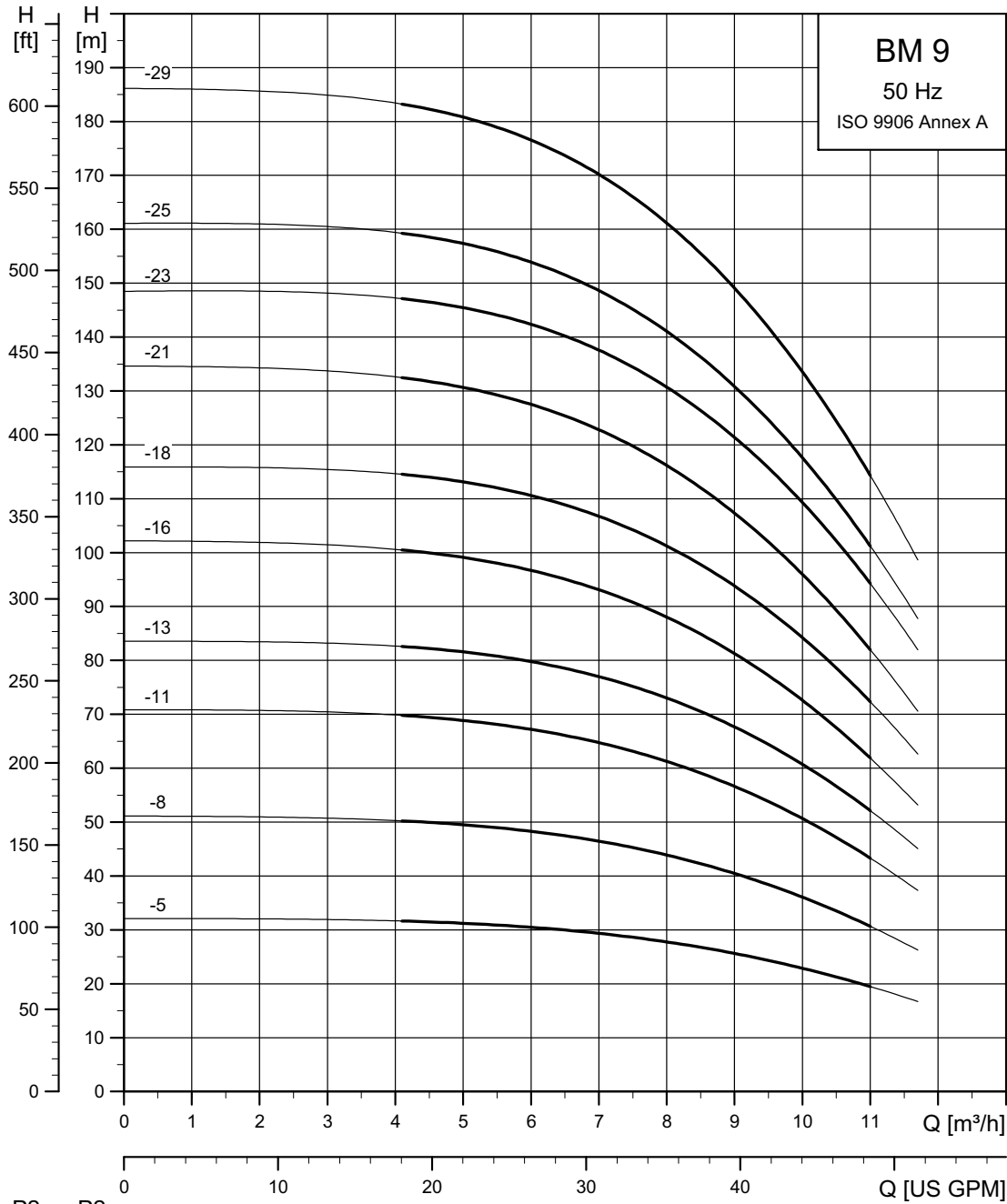

TM06 3383 0215

BM 17

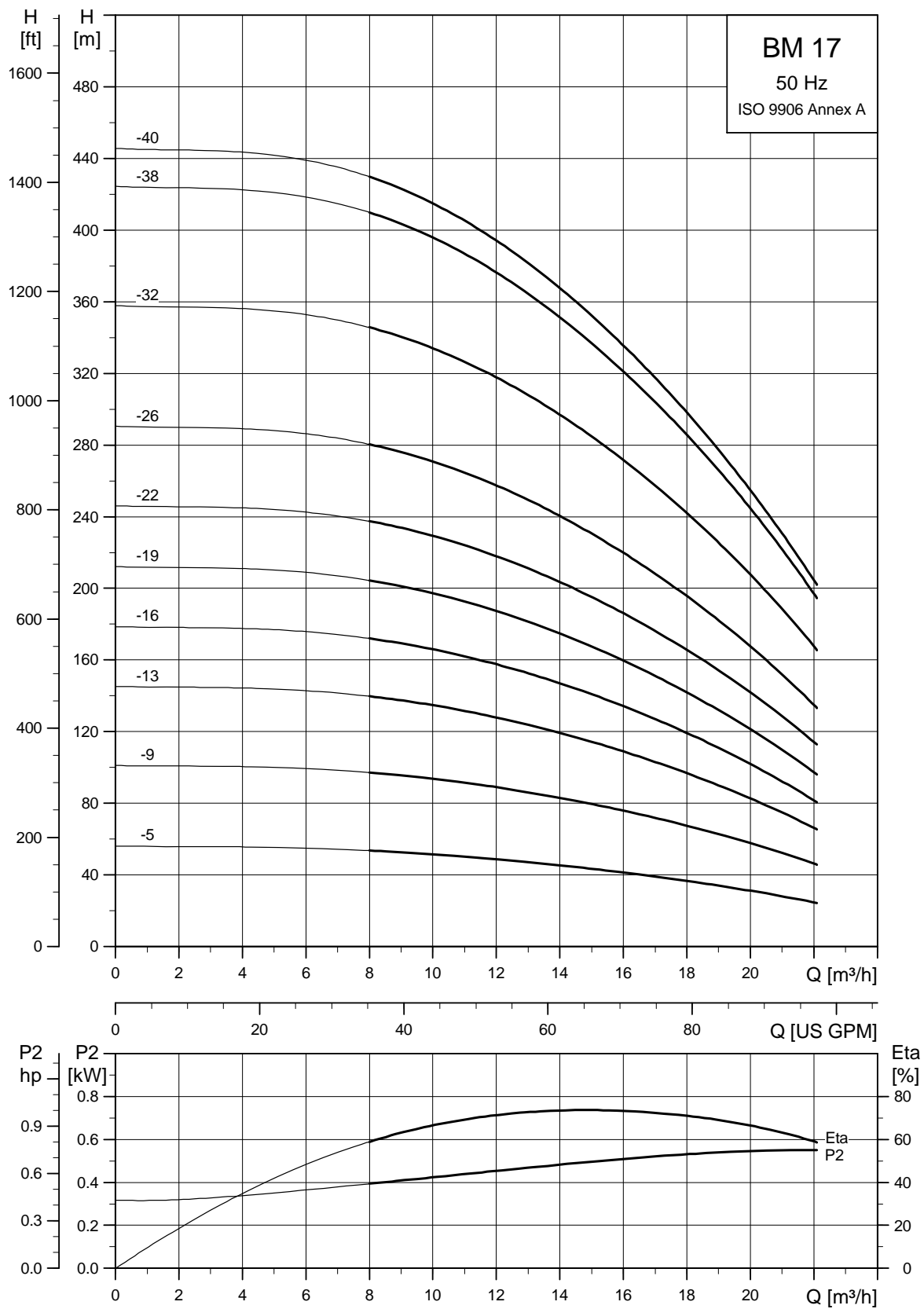

TM00 3699 3712

BM 30

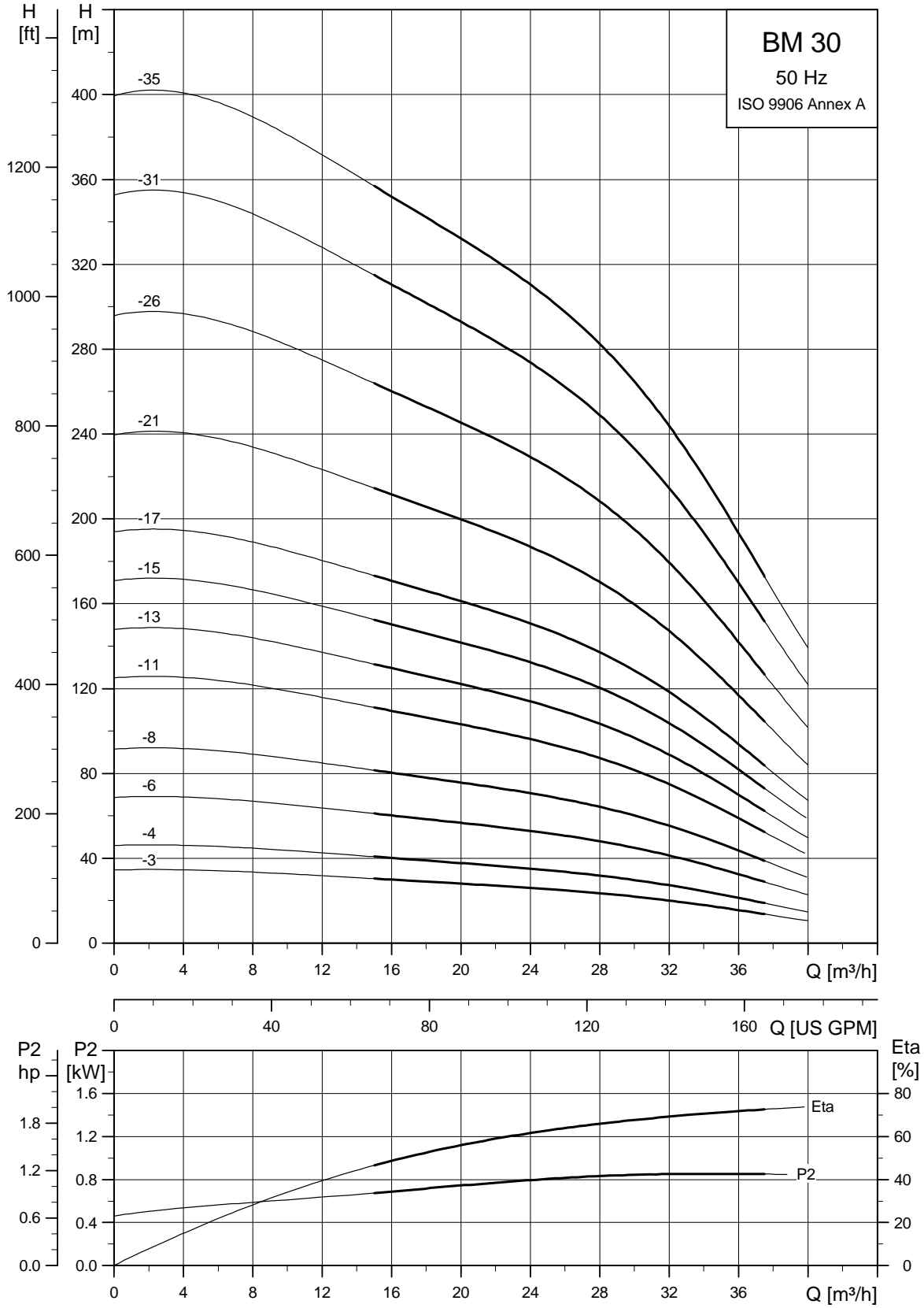

TM01 2074 3712

BM 46

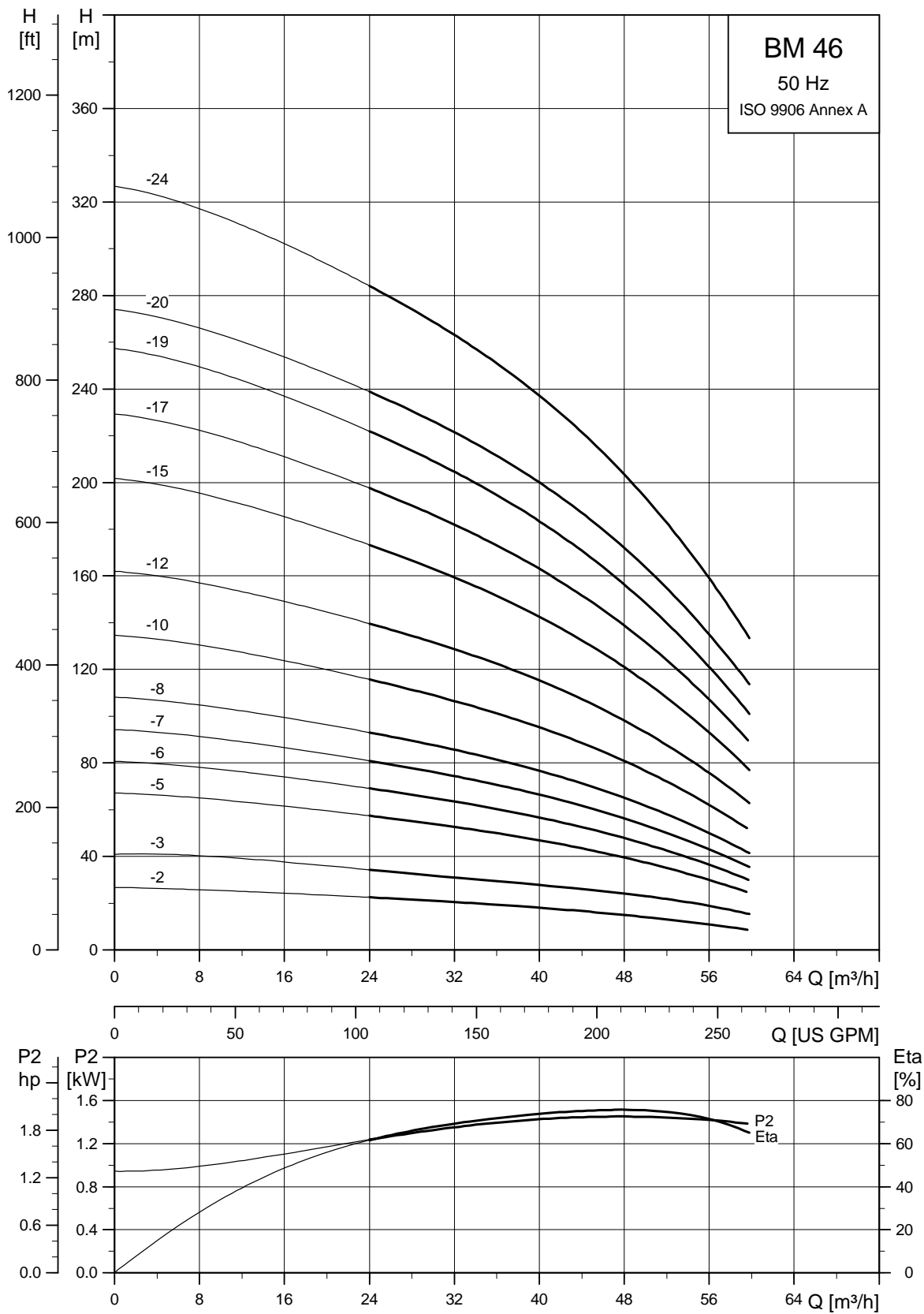

TM01 1217 3400

BM 60

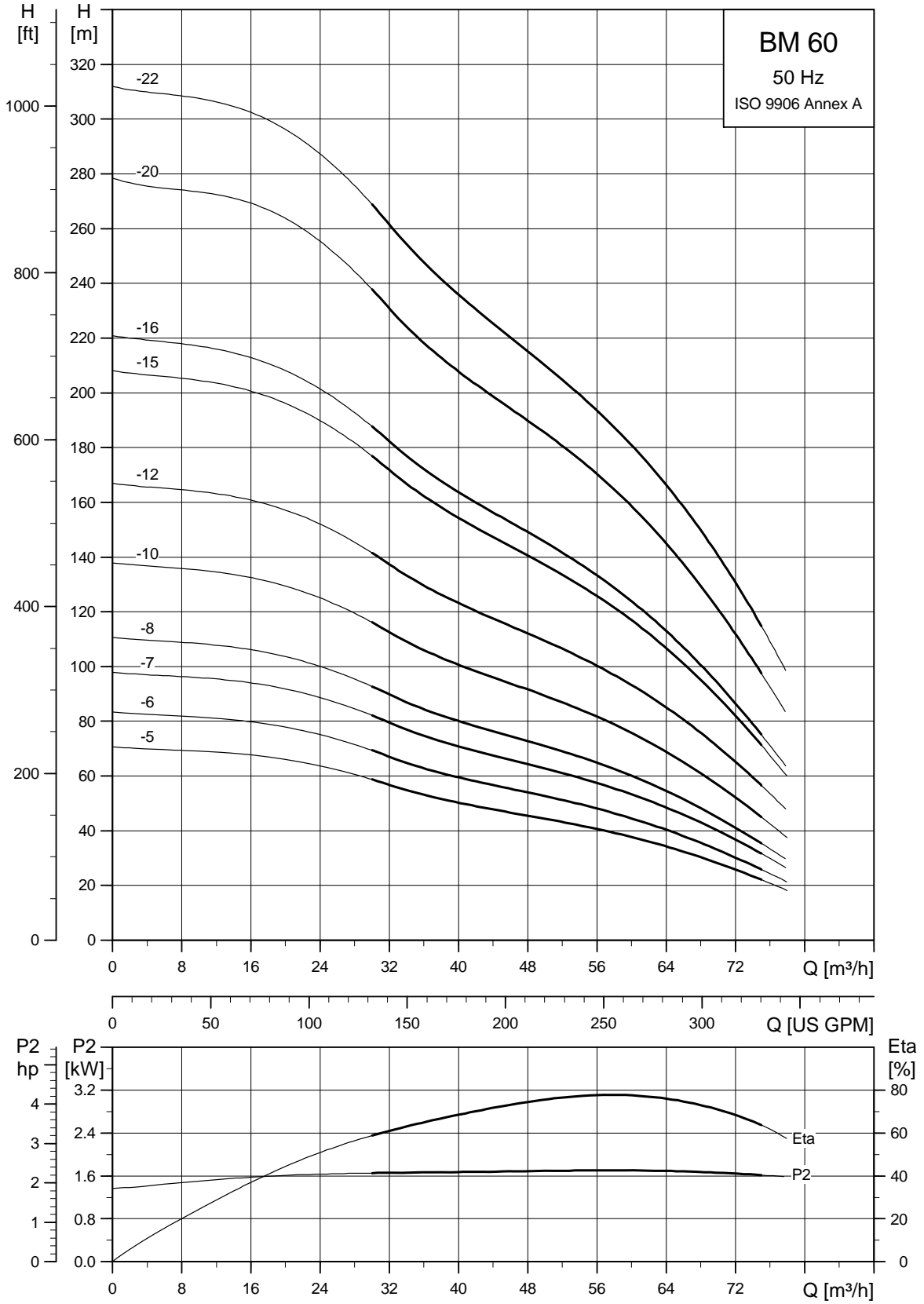

TM01 1218 3400

BM 77

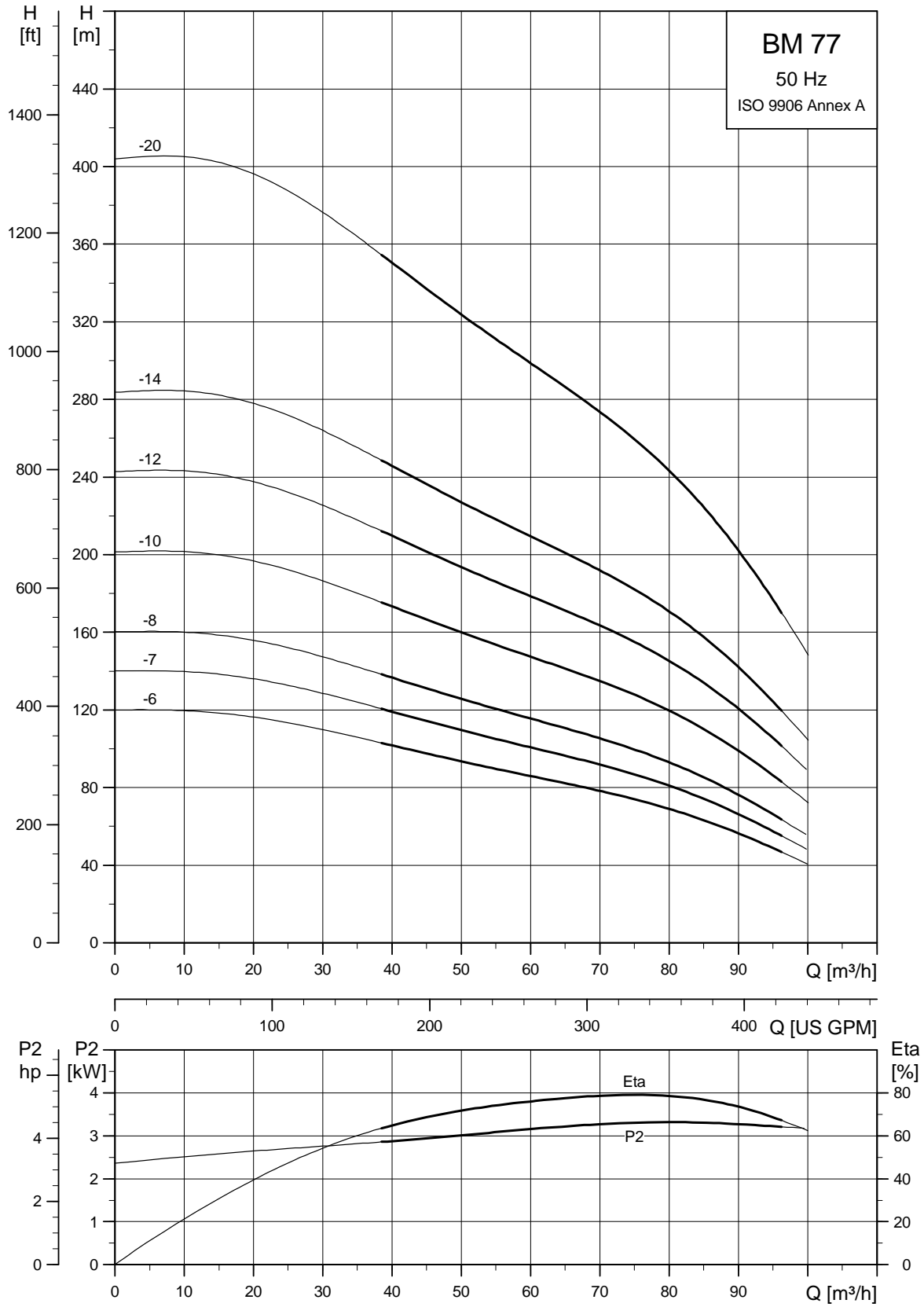

TM01 1219 3712

BM 95

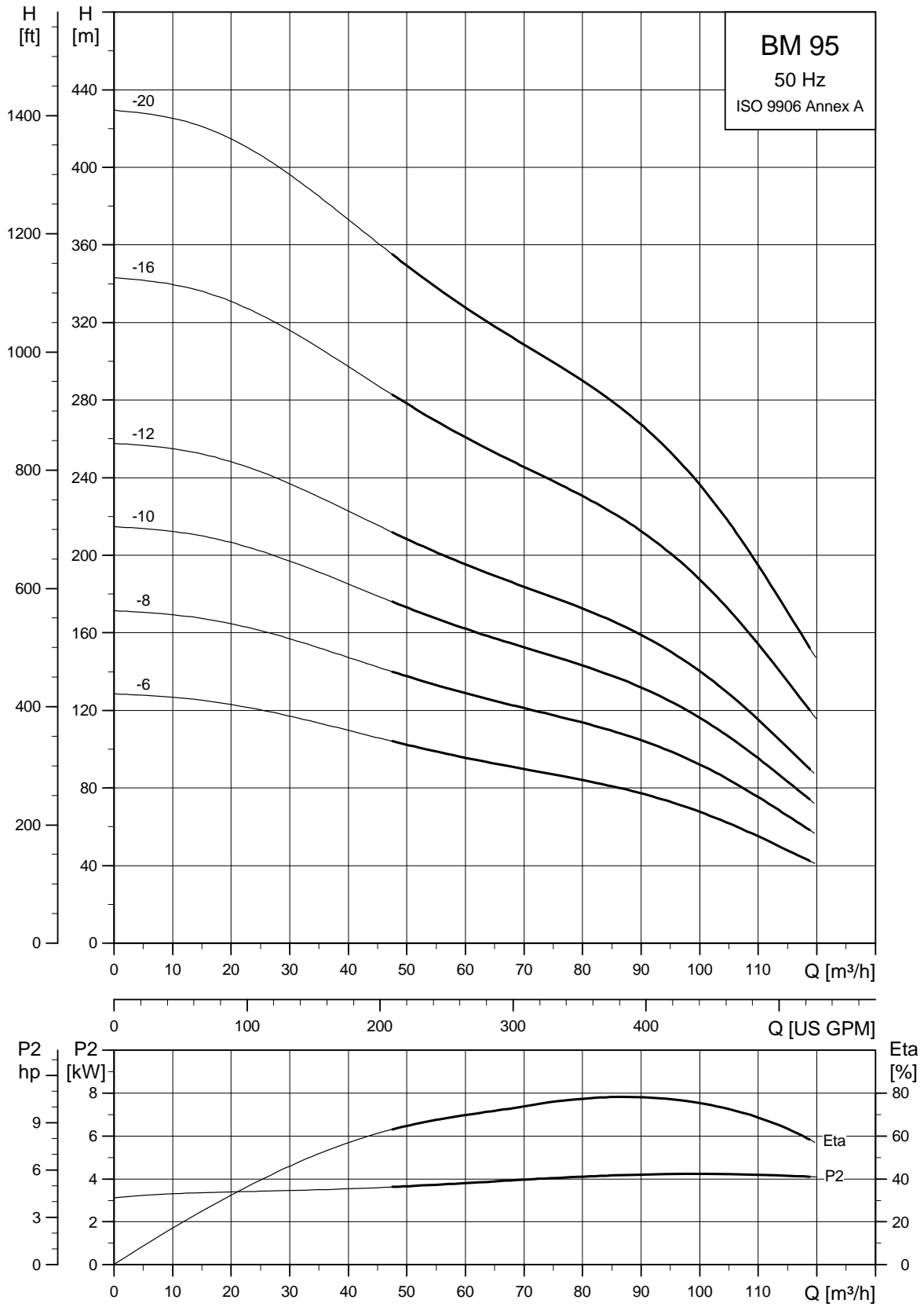

TM01 2075 3712

BM 125

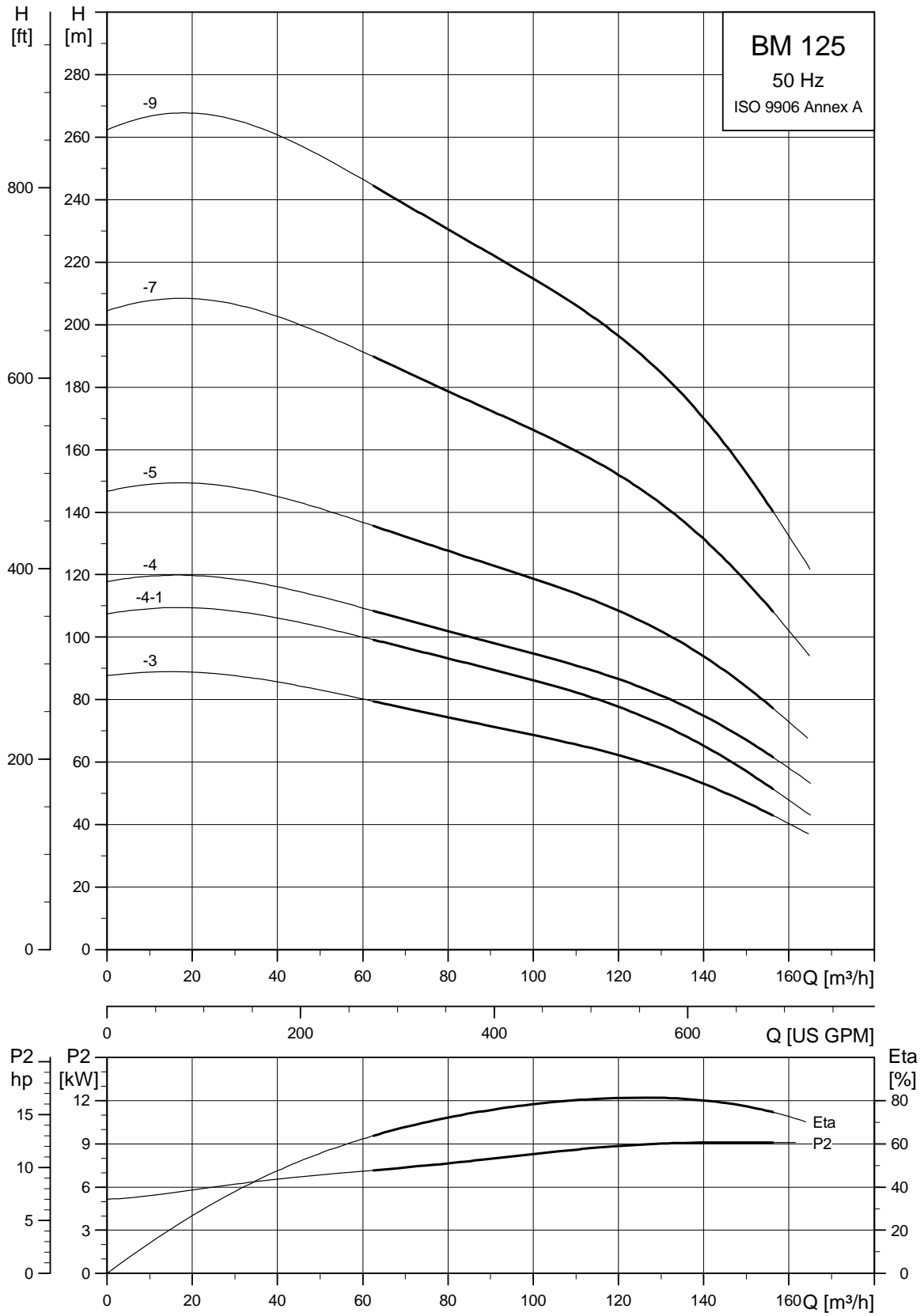

TM01 2076 3712

BM 160

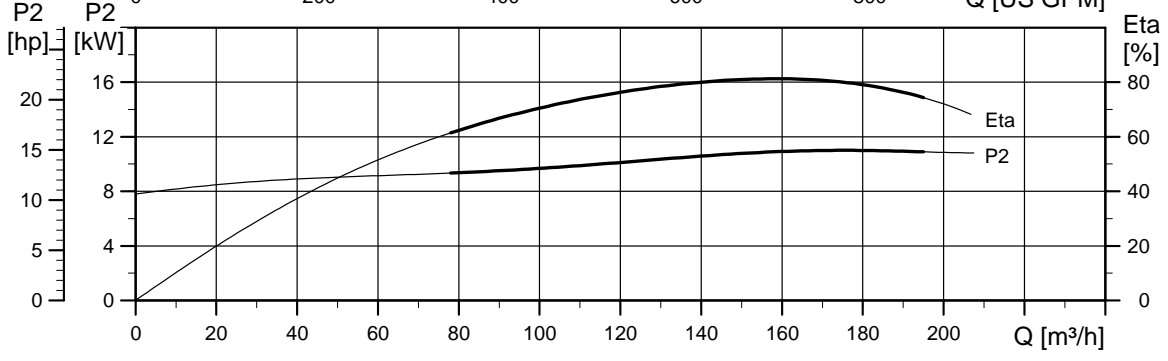
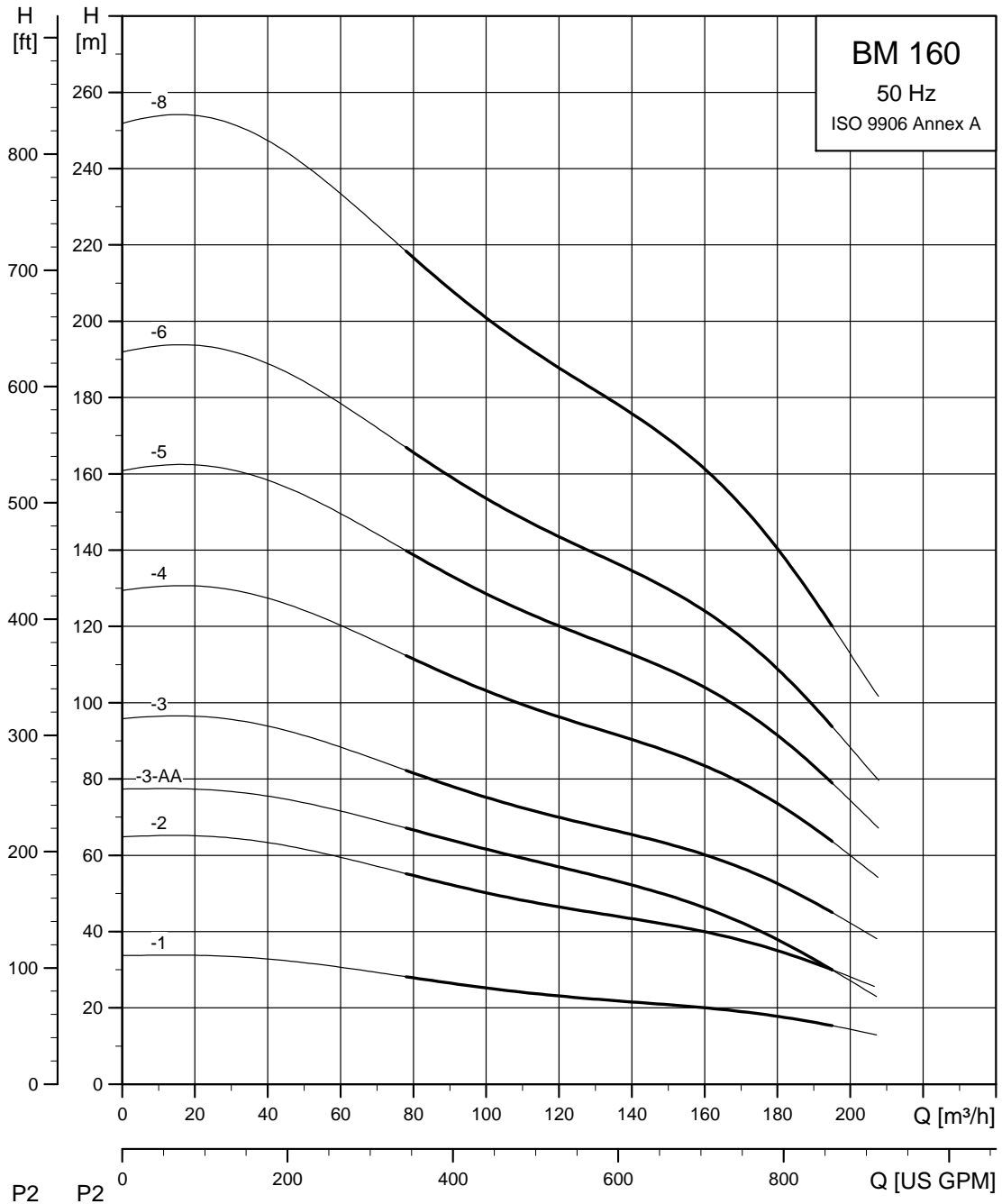

TM04 7951 3712

BM 215

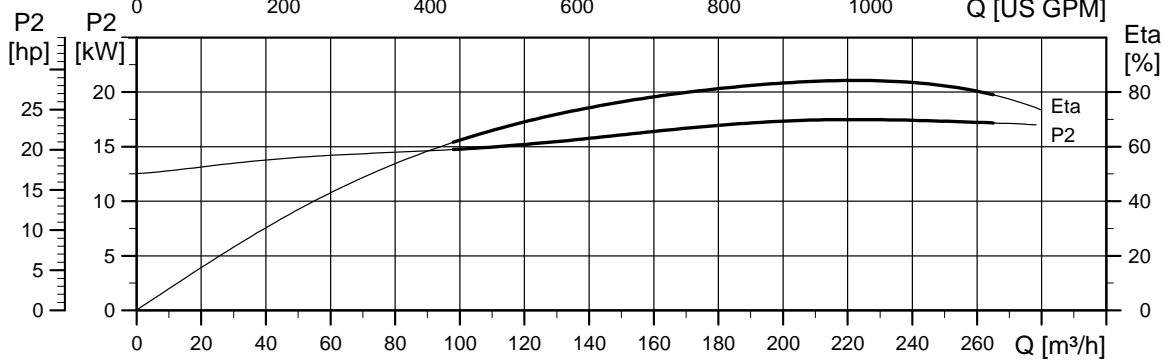
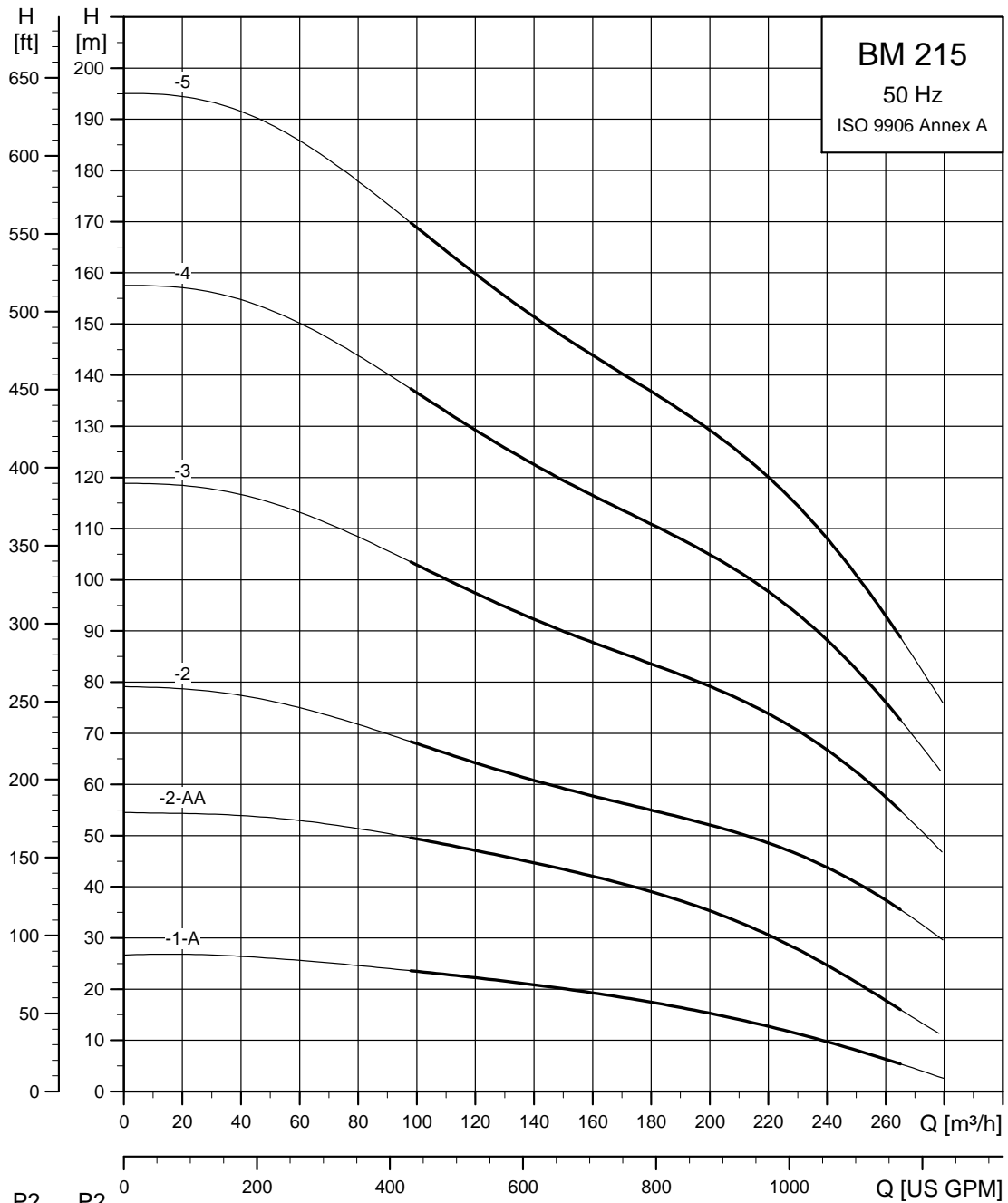

TM04 7953 3712

5. Order data, 50 Hz

BM 4" (with straight pipe)

Type	Motor output [P2]		Rated current I_N [A]	Length [L]		Product number				Weight [kg]		Ship. vol. [m ³]
	[kW]	[hp]		[mm]	[in]	1.4301	N version	NE version	R version	Net	Gross	
BM 3A-6	0.75	1.0	1.92 - 1.84	1222	45.0	10781906	10731906	10741906	-	31.0	37.0	0.123
BM 3A-9	0.75	1.0	1.92 - 1.84	1222	45.0	10781909	10731909	10741909	-	32.0	38.0	0.123
BM 3A-12	0.75	1.0	1.92 - 1.84	1222	45.0	10781912	10731912	10741912	-	33.0	39.0	0.123
BM 3A-18	1.1	1.5	2.80 - 2.75	1369	50.8	10781918	10731918	10741918	-	37.0	43.0	0.136
BM 3A-25	1.5	2.0	3.95 - 4.10	1640	61.5	10781925	10731925	10741925	-	41.0	47.0	0.161
BM 3A-33	2.2	3.0	5.85 - 6.45	1758	66.1	10781933	10731933	10741933	-	46.0	52.0	0.171
BM 3A-45	3.0	4.0	7.7 - 8.10	1986	75.1	10781945	10731945	10741945	-	53.0	59.0	0.192
BM 3A-52	4.0	5.5	9.75 - 9.80	2346	89.3	10781952	10731952	10741952	-	62.0	69.0	0.225
BM 3A-60	4.0	5.5	9.75 - 9.80	2490	95.0	10781960	10731960	10741960	-	65.0	72.0	0.238
BM 5A-12	1.1	1.5	2.80 - 2.75	1222	45.0	05781912	05731912	05741912	05771912	34.0	40.0	0.123
BM 5A-17	1.5	2.0	3.95 - 4.10	1369	50.8	05781917	05731917	05741917	05771917	36.0	42.0	0.136
BM 5A-25	2.2	3.0	5.85 - 6.45	1640	61.5	05781925	05731925	05741925	05771925	43.0	49.0	0.161
BM 5A-33	3.0	4.0	7.7 - 8.10	1986	75.1	05781933	05731933	05741933	05771933	49.0	55.0	0.192
BM 5A-38	4.0	5.5	9.75 - 9.80	1986	75.1	05781938	05731938	05741938	05771938	54.0	60.0	0.192
BM 5A-44	4.0	5.5	9.75 - 9.80	2112	80.1	05781944	05731944	05741944	05771944	57.0	64.0	0.204
BM 5A-60	5.5	7.5	13.0 - 13.4	2490	98.0	05781960	05731960	05741960	05771960	70.0	77.0	0.238
BM 9-5	1.1	1.5	3.05 - 2.10	1222	48.1	98823526	98823554	98823562	98823570	34.0	40.0	0.123
BM 9-8	1.5	2.0	4.10 - 4.15	1472	58	98823527	98823555	98823563	98823571	37.0	43.0	0.145
BM 9-11	2.2	3.0	5.65 - 6.05	1640	64.6	98823528	98823556	98823564	98823572	42.0	48.0	0.161
BM 9-13	3.0	4.0	7.40 - 7.75	1758	69.2	98823529	98823557	98823565	98823573	46.0	52.0	0.171
BM 9-16	3.0	4.0	7.40 - 7.75	1986	78.2	98823530	98823558	98823566	98823574	50.0	56.0	0.192
BM 9-18	4.0	5.5	9.45 - 9.45	2112	83.1	98823551	98823559	98823567	98823575	55.0	61.0	0.204
BM 9-21	4.0	5.5	9.45 - 9.45	2346	92.4	98823552	98823560	98823568	98823576	58.0	64.0	0.225
BM 9-29	5.5	7.5	12.80 - 12.80	2737	107.8	98823553	98823561	98823569	98823577	72.0	78.0	0.260

On request, the BM is available in other voltages and with all stages indicated in the standard SP pump range.

Dimensional sketch

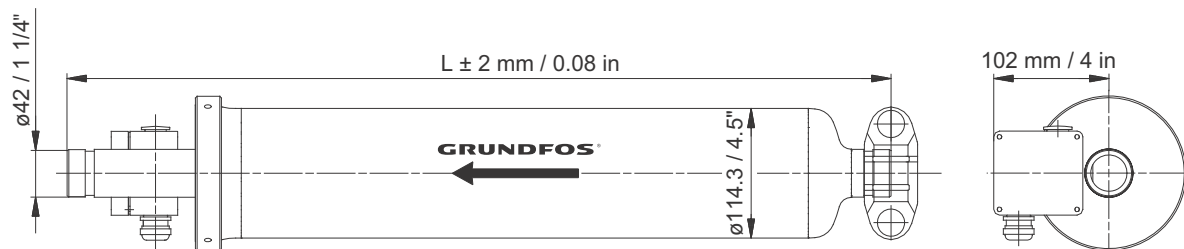

TM00 3797 0299

One set of connecting fittings is required for each system. See section *Accessories*, page 71.

BM 4" (with elbow)

Type	Motor output [P2]		Rated current	Length [L]		Product number				Weight [kg]		Ship. vol.
	[kW]	[hp]	I_N [A]	[mm]	[in]	1.4301	N version	NE version	R version	Net	Gross	[m ³]
BM 3A-6	0.75	1.0	1.92 - 1.84	1144	45.0	10791906	10751906	10761906	-	31.0	37.0	0.115
BM 3A-9	0.75	1.0	1.92 - 1.84	1144	45.0	10791909	10751909	10761909	-	32.0	38.0	0.115
BM 3A-12	0.75	1.0	1.92 - 1.84	1144	45.0	10791912	10751912	10761912	-	33.0	39.0	0.115
BM 3A-18	1.1	1.5	2.80 - 2.75	1291	50.8	10791918	10751918	10761918	-	37.0	43.0	0.129
BM 3A-25	1.5	2.0	3.95 - 4.10	1562	61.5	10791925	10751925	10761925	-	41.0	47.0	0.154
BM 3A-33	2.2	3.0	5.85 - 6.45	1680	66.1	10791933	10751933	10761933	-	46.0	52.0	0.164
BM 3A-45	3.0	4.0	7.7 - 8.10	1908	75.1	10791945	10751945	10761945	-	53.0	59.0	0.185
BM 3A-52	4.0	5.5	9.75 - 9.80	2268	89.3	10791952	10751952	10761952	-	62.0	69.0	0.218
BM 3A-60	4.0	5.5	9.75 - 9.80	2412	95.0	10791960	10751960	10761960	-	65.0	72.0	0.231
BM 5A-12	1.1	1.5	2.80 - 2.75	1144	45.0	05791912	05751912	05761912	05721912	34.0	40.0	0.115
BM 5A-17	1.5	2.0	3.95 - 4.10	1291	50.8	05791917	05751917	05761917	05721917	36.0	42.0	0.129
BM 5A-25	2.2	3.0	5.85 - 6.45	1562	61.5	05791925	05751925	05761925	05721925	43.0	49.0	0.154
BM 5A-33	3.0	4.0	7.7 - 8.10	1908	75.1	05791933	05751933	05761933	05721933	49.0	55.0	0.185
BM 5A-38	4.0	5.5	9.75 - 9.80	1908	75.1	05791938	05751938	05761938	05721938	54.0	60.0	0.185
BM 5A-44	4.0	5.5	9.75 - 9.80	2034	80.1	05791944	05751944	05761944	05721944	57.0	64.0	0.196
BM 5A-60	5.5	7.5	13.0 - 13.4	2412	95.0	05791960	05751960	05761960	05721960	70.0	77.0	0.231
BM 9-5	1.1	1.5	3.05 - 2.10	1144	45	98823578	98823586	98823594	98823602	34.0	40.0	0.115
BM 9-8	1.5	2.0	4.10 - 4.15	1394	54.9	98823579	98823587	98823595	98823603	37.0	43.0	0.138
BM 9-11	2.2	3.0	5.65 - 6.05	1562	61.5	98823580	98823588	98823596	98823604	42.0	48.0	0.154
BM 9-13	3.0	4.0	7.40 - 7.75	1680	66.1	98823581	98823589	98823597	98823605	46.0	52.0	0.164
BM 9-16	3.0	4.0	7.40 - 7.75	1908	75.1	98823582	98823590	98823598	98823606	50.0	56.0	0.185
BM 9-18	4.0	5.5	9.45 - 9.45	2034	80.1	98823583	98823591	98823599	98823607	55.0	61.0	0.196
BM 9-21	4.0	5.5	9.45 - 9.45	2268	89.3	98823584	98823592	98823600	98823608	58.0	64.0	0.218
BM 9-29	5.5	7.5	12.80 - 12.80	2707	106.6	98823585	98823593	98823601	98823609	72.0	78.0	0.258

On request, the BM is available in other voltages, with all stages indicated in the standard SP pump range and in R version.

Dimensional sketch

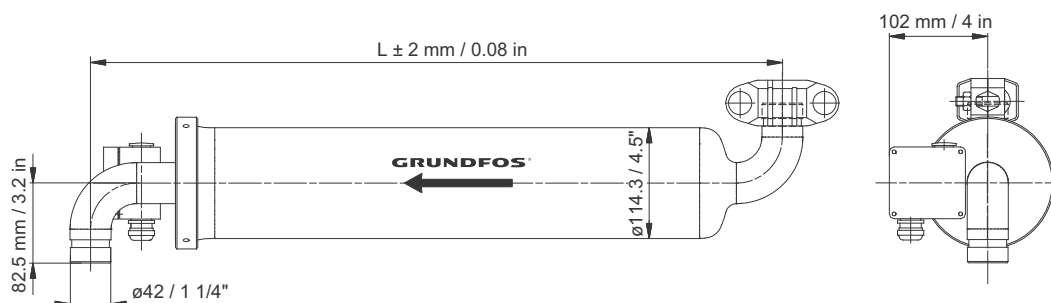

TM00 3798 0299

One set of connecting fittings is required for each system. See section *Accessories*, page 71.

BM 6" (with straight pipe)

Type	Motor output [P2]		Rated current	Length [L]		Product number				Weight [kg]		Ship. vol.
	[kW]	[hp]	I _N [A]	[mm]	[in]	1.4301	N version	NE version	R version	Net	Gross	[m ³]
BM 17-5	3.0	4.0	7.7 - 8.10	1550	61.0	98490776	12CE1905	12CF1905	12CU1905	49	71	0.273
BM 17-7	4.0	5.5	9.75 - 9.80	1750	68.9	98490777	12CE1907	12CF1907	12CU1907	59	85	0.304
BM 17-9	5.5	7.5	13.0 - 13.4	1950	76.8	98490778	12CE1909	12CF1909	12CU1909	69	99	0.335
BM 17-13	7.5	10	17.6 - 17.8	2200	86.6	98490779	12CE1913	12CF1913	12CU1913	90	128	0.340
BM 17-16	9.2	12.5	21.8 - 21.8	2500	98.4	98490780	12CE1916	12CF1916	12CU1916	104	148	0.421
BM 17-19	11	15	25.5 - 24.8	2700	106.3	98490781	12CE1919	12CF1919	12CU1919	114	162	0.452
BM 17-22	13	17.5	30.5 - 30.0	2850	112.2	98490782	12CE1922	12CF1922	12CU1922	122	173	0.476
BM 17-26	15	20	34.5 - 34.0	3050	120.1	98490783	12CE1926	12CF1926	12CU1926	134	190	0.507
BM 17-32	18.5	25	42.0 - 42.5	3800	149.6	98490784	12CE1932	12CF1932	12CU1932	158	223	0.624
BM 17-38	22	30	50.0 - 47.5	4250	167.3	98490785	12CE1938	12CF1938	12CU1938	178	251	0.694
BM 17-40	22	30	47.5 - 50.0	4250	167.3	98490786	12CE1940	12CF1940	12CU1940	181	255	0.694
BM 30-3	3.0	4.0	7.7 - 8.10	1550	61.0	98490787	13CE1903	13CF1903	13CU1903	48	69	0.273
BM 30-4	4.0	5.5	9.75 - 9.80	1750	68.9	98490788	13CE1904	13CF1904	13CU1904	56	80	0.304
BM 30-6	5.5	7.5	13.0 - 13.4	2100	82.7	98490789	13CE1906	13CF1906	13CU1906	67	96	0.335
BM 30-8	7.5	10	17.6 - 17.8	2100	82.7	98490790	13CE1908	13CF1908	13CU1908	87	124	0.356
BM 30-11	9.2	12.5	21.8 - 21.8	2500	98.4	98490791	13CE1911	13CF1911	13CU1911	103	146	0.421
BM 30-13	11	15	25.5 - 24.8	2700	106.3	98490792	13CE1913	13CF1913	13CU1913	113	160	0.452
BM 30-15	13	17.5	30.5 - 30.0	2850	112.2	98490793	13CE1915	13CF1915	13CU1915	121	171	0.476
BM 30-17	15	20	34.5 - 34.0	3200	126.0	98490794	13CE1917	13CF1917	13CU1917	131	185	0.530
BM 30-21	18.5	25	42.0 - 42.5	3800	149.6	98490795	13CE1921	13CF1921	13CU1921	155	219	0.624
BM 30-26	22	30	50.0 - 47.5	4250	167.3	98490796	13CE1926	13CF1926	13CU1926	176	248	0.694
BM 30-31	26	35	59.0 - 57.0	4950	194.9	98490797	13CE1931	13CF1931	13CU1931	195	275	0.713
BM 30-35	30	40	68.5 - 66.5	5100	200.8	98490798	13CE1935	13CF1935	13CU1935	216	304	0.735
BM 46-2	3.0	4.0	7.7 - 8.10	1550	61.0	98490799	15C81902	15C91902	15C71902	46	66	0.273
BM 46-3	5.5	7.5	13.0 - 13.4	1750	68.9	98490800	15C81903	15C91903	15C71903	63	90	0.304
BM 46-5	7.5	10	17.6 - 17.8	1950	76.8	98490801	15C81905	15C91905	15C71905	82	117	0.335
BM 46-6	9.2	12.5	21.8 - 21.8	2100	82.7	98490802	15C81906	15C91906	15C71906	94	134	0.356
BM 46-7	11	15	25.5 - 24.8	2200	86.6	98490803	15C81907	15C91907	15C71907	101	143	0.374
BM 46-8	13	17.5	30.5 - 30.0	2500	98.4	98490804	15C81908	15C91908	15C71908	108	153	0.421
BM 46-10	15	20	34.5 - 34.0	2700	106.3	98490805	15C81910	15C91910	15C71910	123	174	0.452
BM 46-12	18.5	25	42.0 - 42.5	3050	120.1	98490806	15C81912	15C91912	15C71912	136	192	0.507
BM 46-15	22	30	50.0 - 47.5	3400	133.9	98490807	15C81915	15C91915	15C71915	157	222	0.562
BM 46-17	26	35	59.0 - 57.0	3800	149.6	98490808	15C81917	15C91917	15C71917	174	246	0.624
BM 46-19	30	40	68.5 - 66.5	4250	167.3	98490809	15C81919	15C91919	15C71919	187	264	0.694
BM 60-5	9.2	12.5	21.8 - 21.8	1950	76.8	98490810	14CE1905	14CF1905	14C71905	89	127	0.335
BM 60-6	11	15	25.5 - 24.8	2100	82.7	98490811	14CE1906	14CF1906	14C71906	98	139	0.356
BM 60-7	13	17.5	30.5 - 30.0	2200	86.6	98490812	14CE1907	14CF1907	14C71907	104	148	0.390
BM 60-8	15	20	34.5 - 34.0	2500	98.4	98490813	14CE1908	14CF1908	14C71908	116	164	0.421
BM 60-10	18.5	25	42.0 - 42.5	2700	106.3	98490814	14CE1910	14CF1910	14C71910	129	183	0.452
BM 60-12	22	30	50.0 - 47.5	3050	120.1	98490815	14CE1912	14CF1912	14C71912	145	205	0.507
BM 60-15	26	35	59.0 - 57.0	3400	133.9	98490816	14CE1915	14CF1915	14C71915	163	230	0.562
BM 60-16	30	40	68.5 - 66.5	3800	149.6	98490817	14CE1916	14CF1916	14C71916	180	254	0.624

On request, the BM is available in other voltages and with all stages indicated in the standard SP pump range.

Dimensional sketch

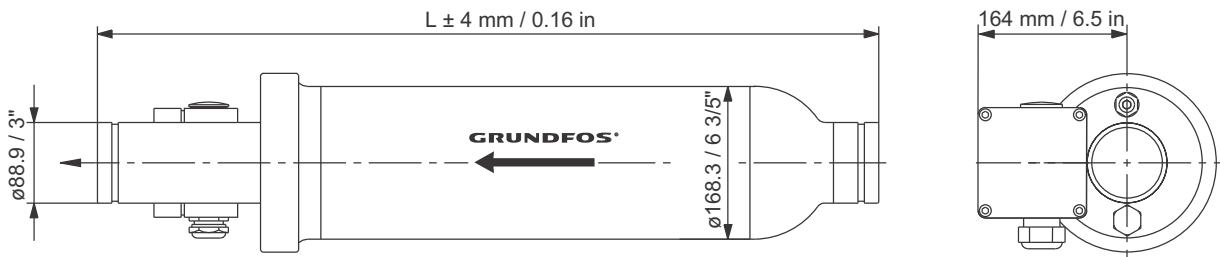

TM00 3799 4312

One set of connecting fittings is required for each system. See section *Accessories*, page 71.

BM 8" (with straight pipe)

Type	Motor output [P2]		Rated current I_N [A]	Length [L]		Product number				Weight [kg]		Ship. vol. [m ³]
	[kW]	[hp]		[mm]	[in]	1.4301	N version	NE version	R version	Net	Gross	
BM 46-20	37	50	81.5 - 77.0	4150	175.2	15CS1920	15CR1920	15CT1920	15CU1920	320	418	1.65
BM 46-24	37	50	81.5 - 77.0	4950	194.9	15CS1924	15CR1924	15CT1924	15CU1924	351	442	1.83
BM 60-20	37	50	81.5 - 77.0	4150	163.4	14CS1920	14CR1920	14CT1920	14CU1920	324	422	1.54
BM 60-22	45	60	96.5 - 95.5	4450	175.2	14CS1922	14CR1922	14CT1922	14CU1922	355	453	1.65
BM 77-6	22	30	50.0 - 47.5	2750	108.3	16CS1906	16CE1906	16CF1906	16CU1906	185	246	1.04
BM 77-7	26	35	59.0 - 57.0	2750	108.3	16CS1907	16CE1907	16CF1907	16CU1907	194	255	1.04
BM 77-8	30	40	68.5 - 66.5	3200	126.0	16CS1908	16CE1908	16CF1908	16CU1908	216	286	1.20
BM 77-10	37	50	81.5 - 77.0	3450	135.8	16CS1910	16CR1910	16CT1910	16CU1910	307	383	1.29
BM 77-12	45	60	96.5 - 95.5	3800	149.6	16CS1912	16CR1912	16CT1912	16CU1912	343	427	1.42
BM 77-14	55	75	116-112	4150	163.4	16CS1914	16CR1914	16CT1914	16CU1914	373	464	1.54
BM 77-20	75	100	156-152	5300	208.6	16CS1920	16CR1920	16CT1920	16CU1920	479	603	2.06
BM 95-6	26	35	59.0 - 57.0	2750	108.3	19CS1906	19581906	19591906	19601906	190	250	1.04
BM 95-8	37	50	81.5 - 77.0	3200	126.0	19CS1908	19651908	19661908	19671908	294	364	1.20
BM 95-10	45	60	96.5 - 95.5	3450	135.8	19CS1910	19651910	19661910	19671910	328	403	1.29
BM 95-12	55	75	116-112	3800	149.6	19CS1912	19651912	19661912	19671912	358	441	1.42
BM 95-16	75	100	156-152	4950	194.9	19CS1916	19651916	19661916	19671916	442	550	1.82
BM 95-20	92	123	194-186	5300	208.6	19CS1920	19651920	19661920	19671920	525	649	2.06
BM 125-3	30	40	68.5 - 66.5	2400	94.5	17CS1903	17CE1903	17CF1903	17CU1903	196	249	0.91
BM 125-4-A	37	50	81.5 - 77.0	2750	108.3	17CS19A4	17CR19A4	17CT19A4	17CU19A4	287	348	1.04
BM 125-4	45	60	96.5 - 95.5	3200	126.0	17CS1904	17CR1904	17CT1904	17CU1904	297	367	1.20
BM 125-5	55	75	116-112	3200	126.0	17CS1905	17CR1905	17CT1905	17CU1905	341	415	1.20
BM 125-7	75	100	156-152	3800	149.6	17CS1907	17CR1907	17CT1907	17CU1907	411	498	1.42
BM 125-9	92	123	194-186	4150	163.4	17CS1909	17CR1909	17CT1909	17CU1909	476	567	1.54
BM 160-1	13	17	30.5 - 30.0	2400	94.5	20CS1901	20CR1901	20CT1901	20CU1901	155	208	0.91
BM 160-2	26	35	59-57	2400	94.5	20CS1902	20CR1902	20CT1902	20CU1902	182	235	0.91
BM 160-3-AA	30	40	68.5 - 66.5	2400	94.5	20CS19B3	20CR19B3	20CT19B3	20CU19B3	196	249	0.91
BM 160-3	37	50	81.5 - 77	2750	108.3	20CS1903	20CR1903	20CT1903	20CU1903	281	342	1.04
BM 160-4	55	74	116-112	3200	126.0	20CS1904	20CR1904	20CT1904	20CU1904	335	405	1.20
BM 160-5	63	85	132-130	3200	126.0	20CS1905	20CR1905	20CT1905	20CU1905	367	437	1.20
BM 160-6	75	101	156-152	3800	149.6	20CS1906	20CR1906	20CT1906	20CU1906	405	489	1.42
BM 160-8	92	123	194-186	3800	149.6	20CS1908	20CR1908	20CT1908	20CU1908	470	561	1.54
BM 215-1-A	15	20	34.5 - 34.0	2400	94.5	18CS19A1	18CR19A1	18CT19A1	18CU19A1	165	218	0.91
BM 215-2-AA	30	40	68.5 - 66.5	2400	94.5	18CS19B2	18CR19B2	18CT19B2	18CU19B2	200	253	0.91
BM 215-2	45	60	96.5 - 95	2750	108.3	18CS1902	18CR1902	18CT1902	18CU1902	308	369	1.04
BM 215-3	63	85	132-130	3200	126.0	18CS1903	18CR1903	18CT1903	18CU1903	369	439	1.20
BM 215-4	75	101	156-152	3800	149.6	18CS1904	18CR1904	18CT1904	18CU1904	411	495	1.42
BM 215-5	92	123	194-186	3800	149.6	18CS1905	18CR1905	18CT1905	18CU1905	474	565	1.54

On request, the BM is available in other voltages and with all stages indicated in the standard SP pump range.

Connections

Size	Type	Victaulic coupling, style 77
BM 8"	BM 30 - BM 46	3" / Ø89
BM 8"	BM 60	4" / Ø114
BM 8"	BM 77 - BM 95	5" / Ø139
BM 8"	BM 125 - BM 215	6" / Ø168

Dimensional sketch

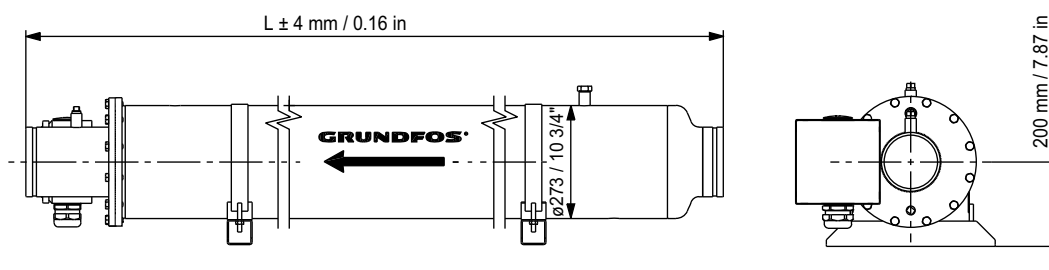

One set of connecting fittings is required for each system. See section *Accessories*, page 71.

TM01 1424 3812

6. Performance curves, 60 Hz

BM 3A

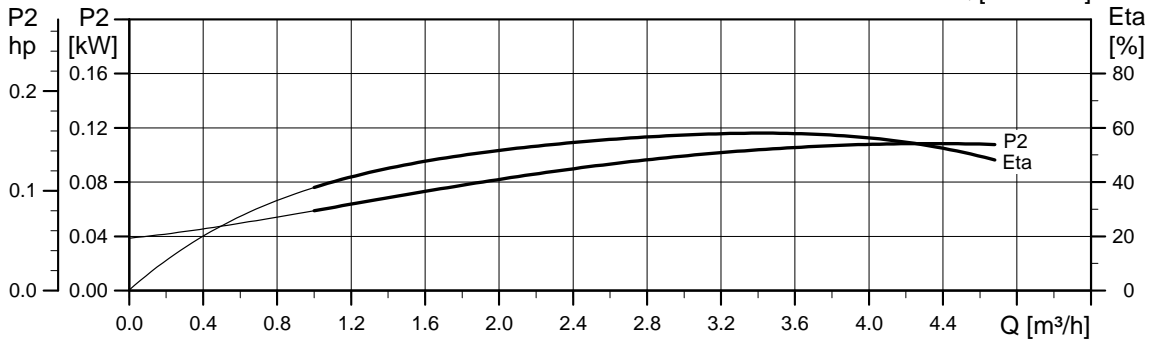
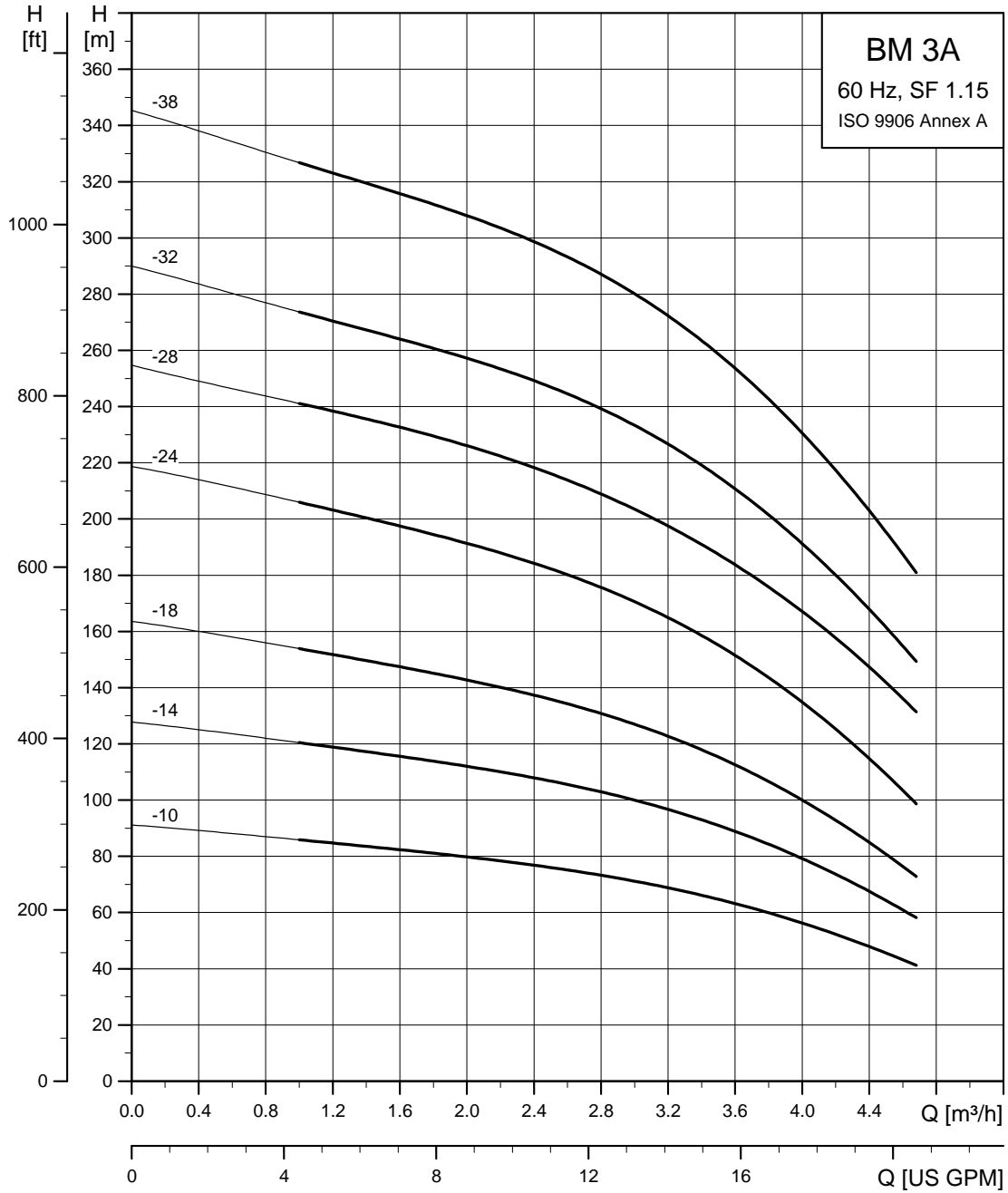

TM01 1220 3712

BM 5A

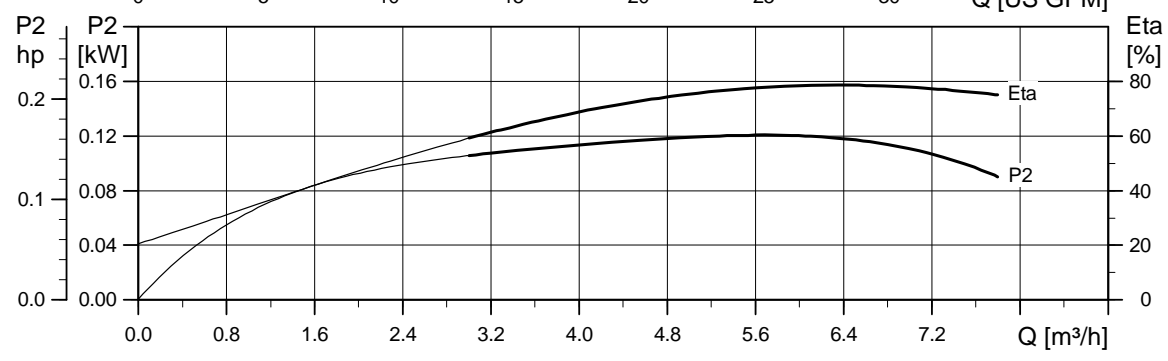
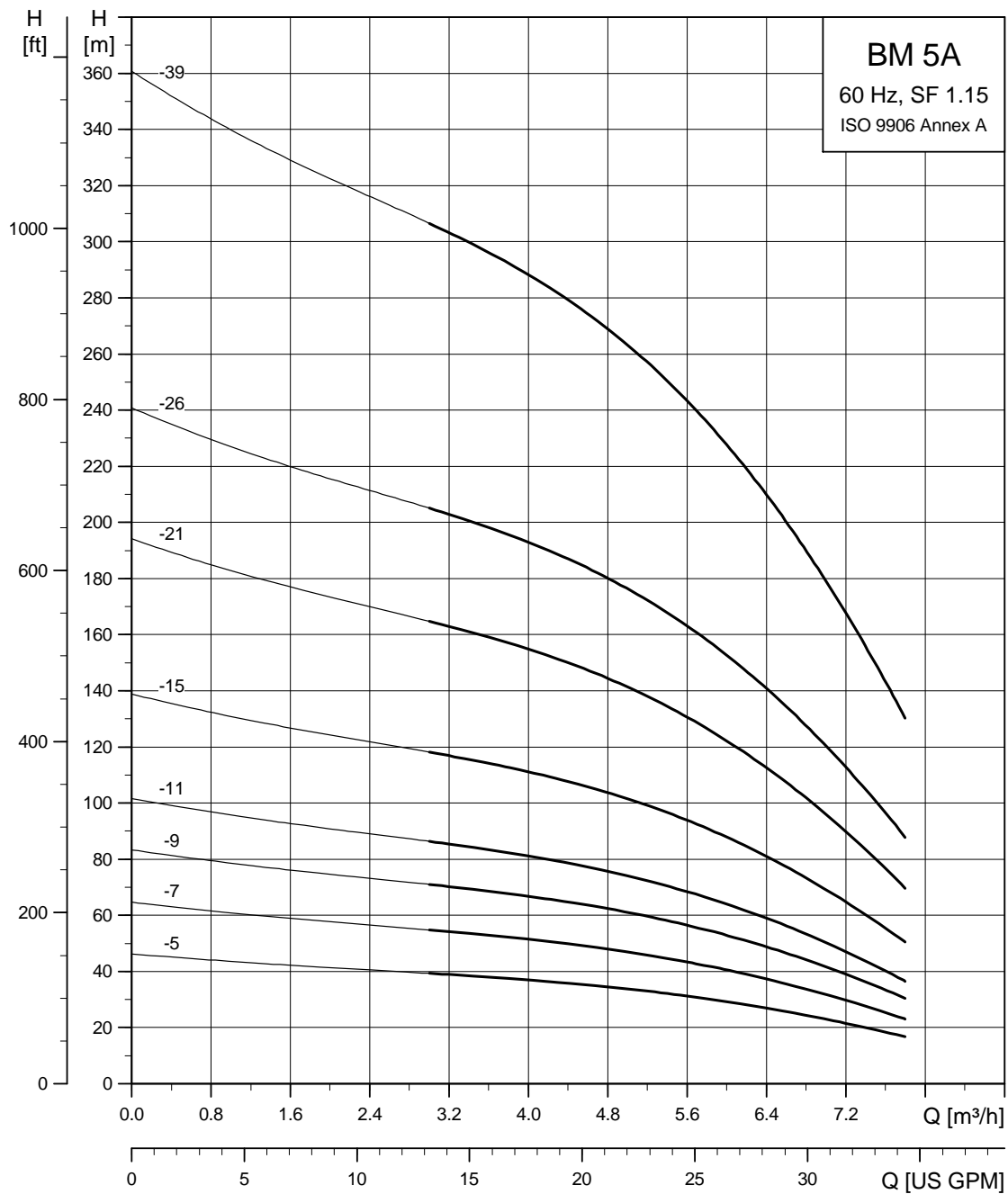

TM01 1221 3400

BM 9

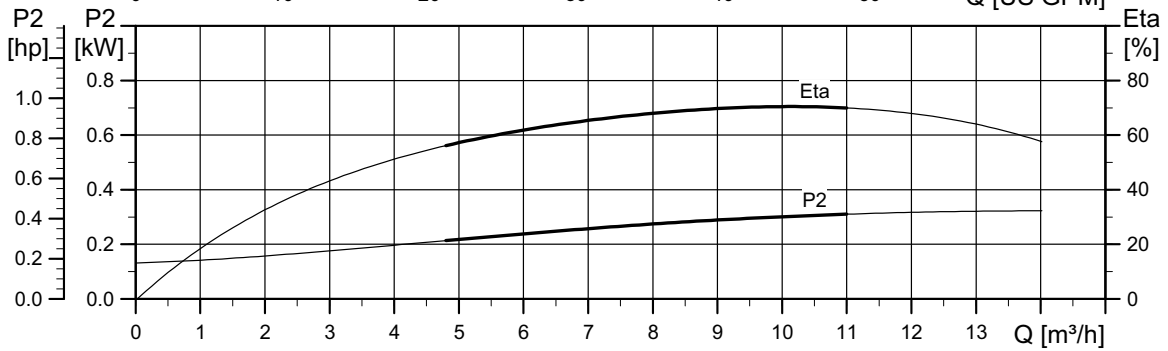
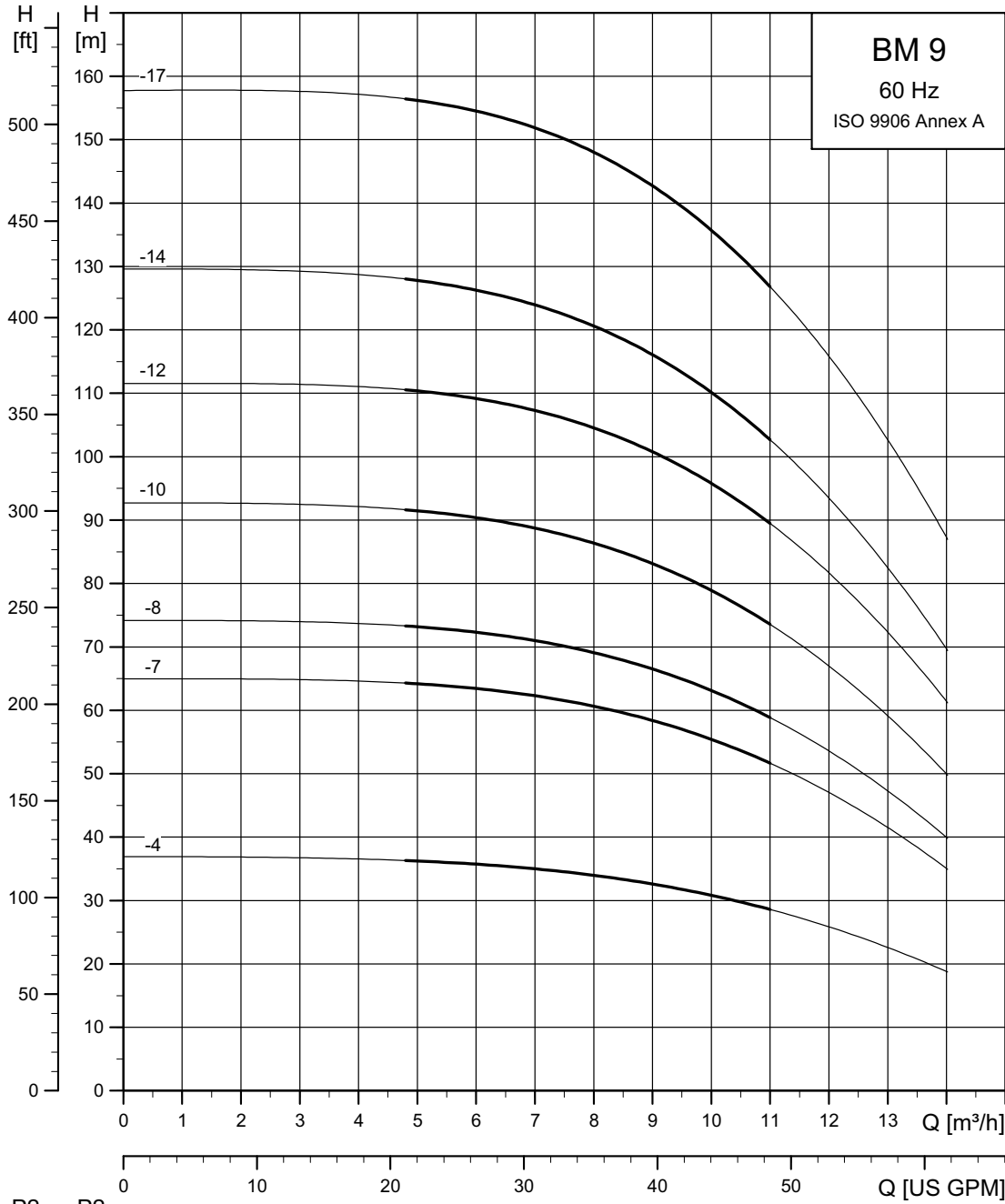

TM06 3384 0215

BM 17

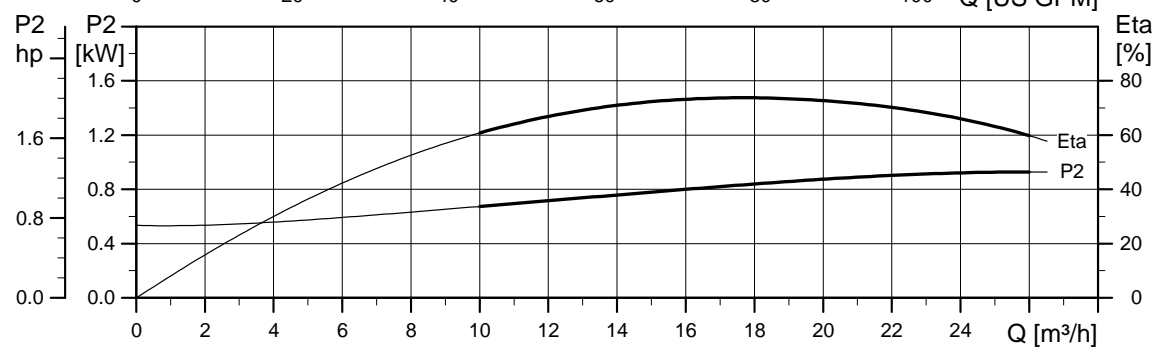
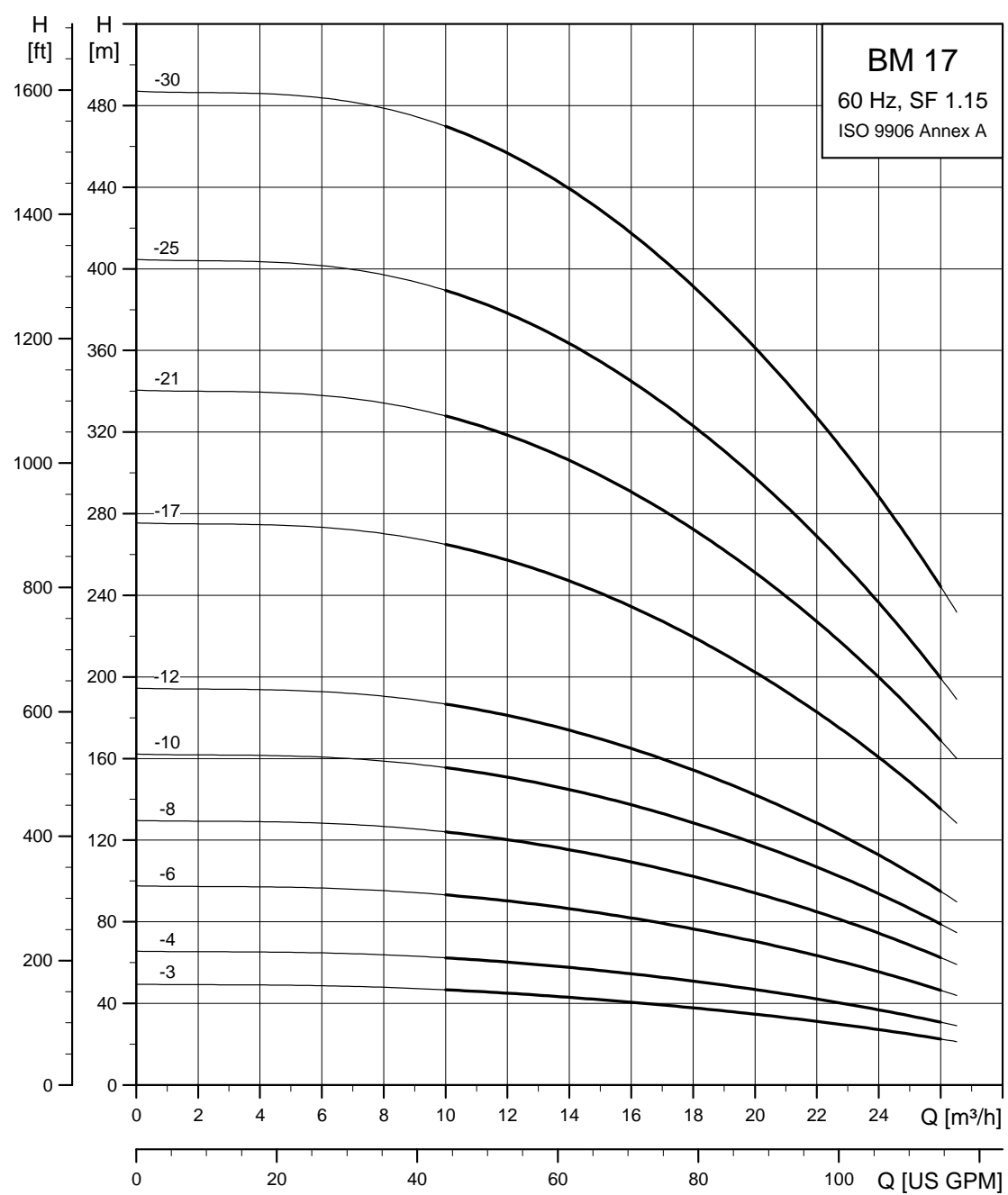

TM00 4164 3-400

BM 30

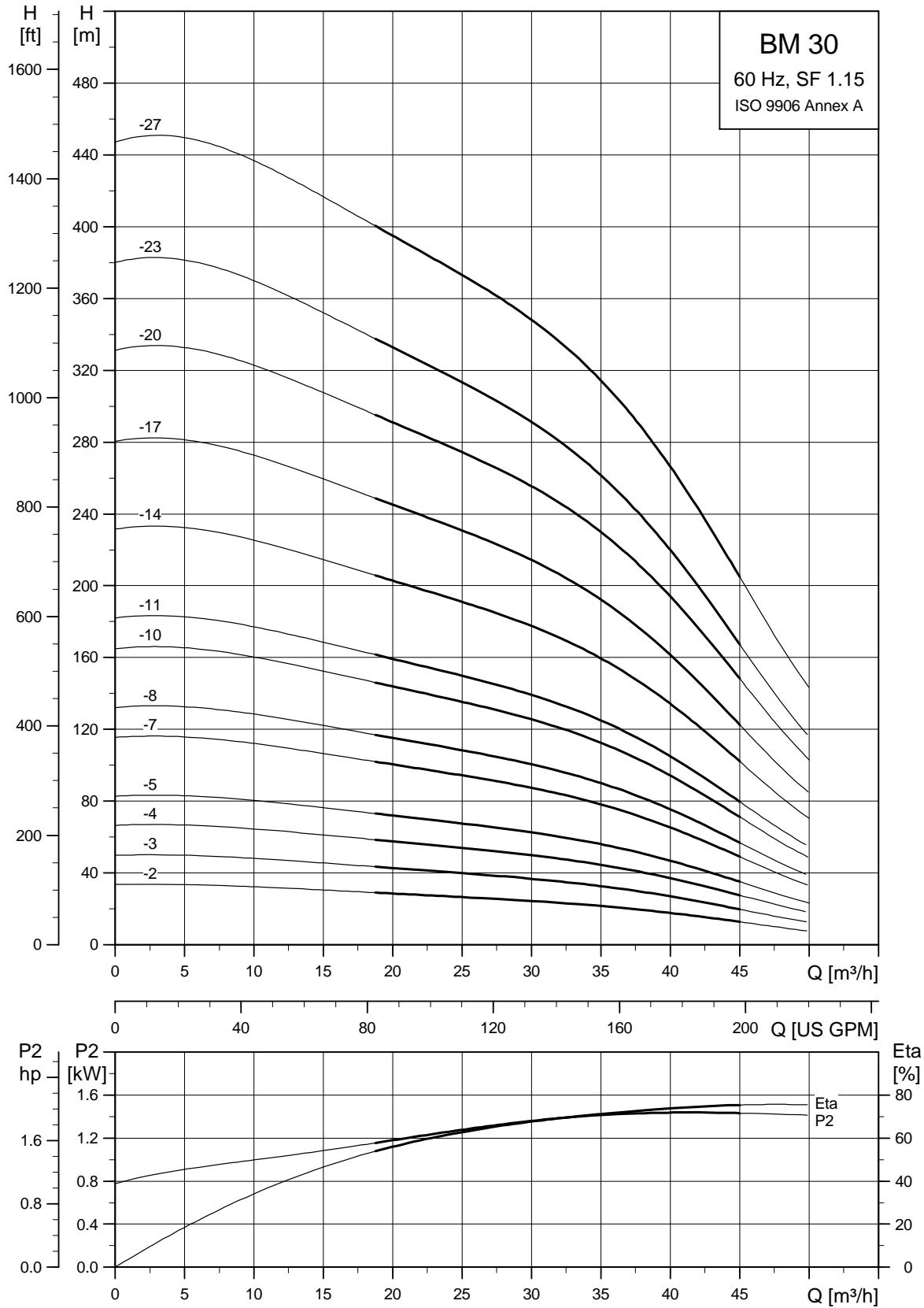

TM01 2078 3712

BM 46

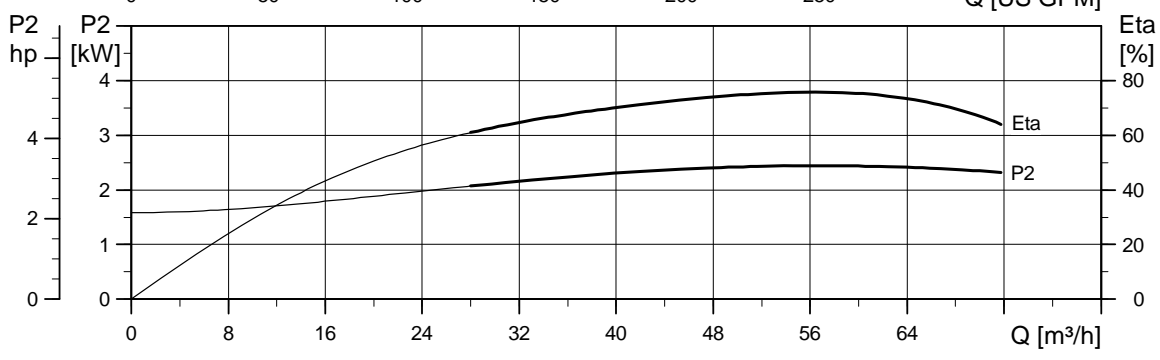
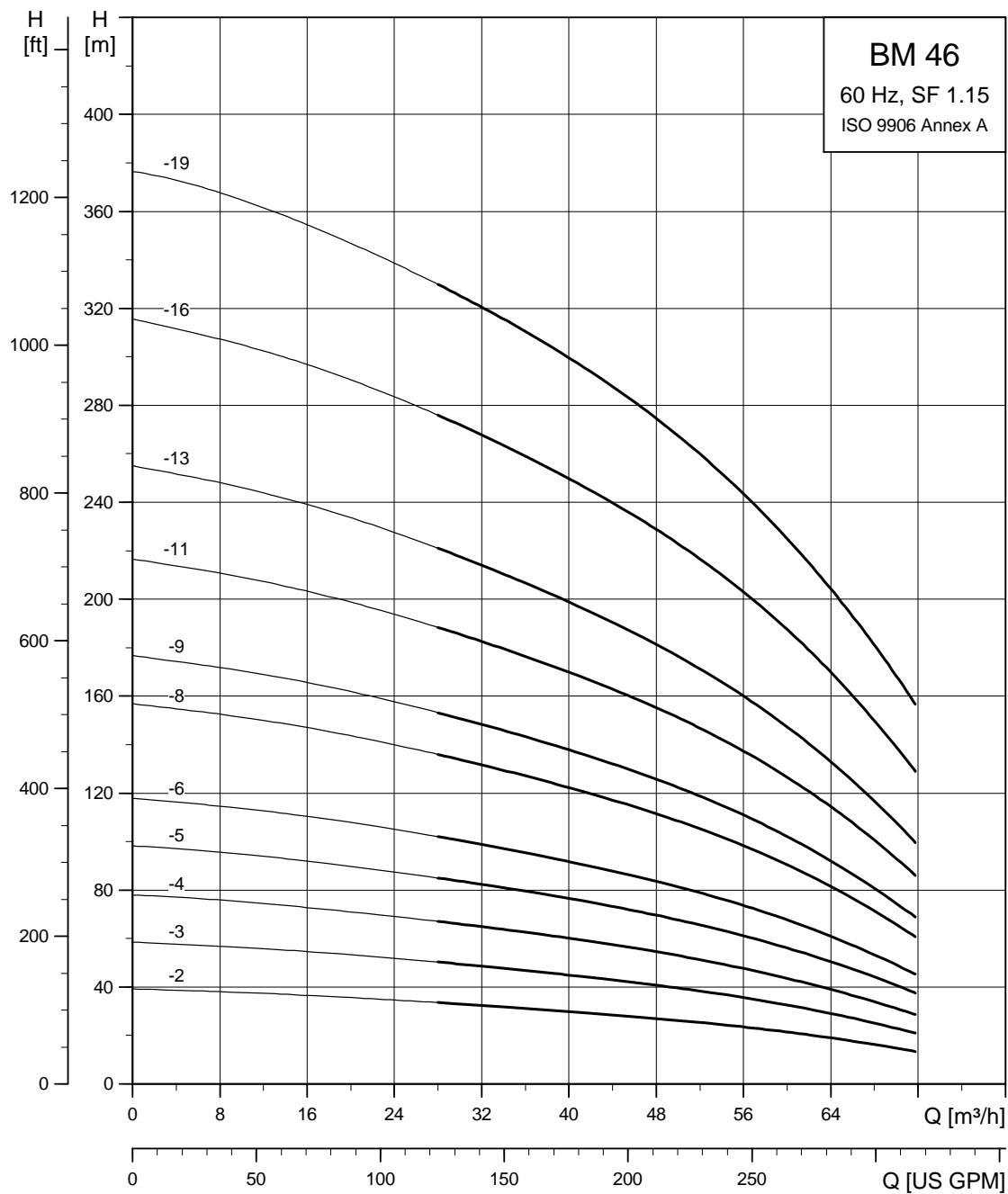

TM01 1225 3400

BM 60

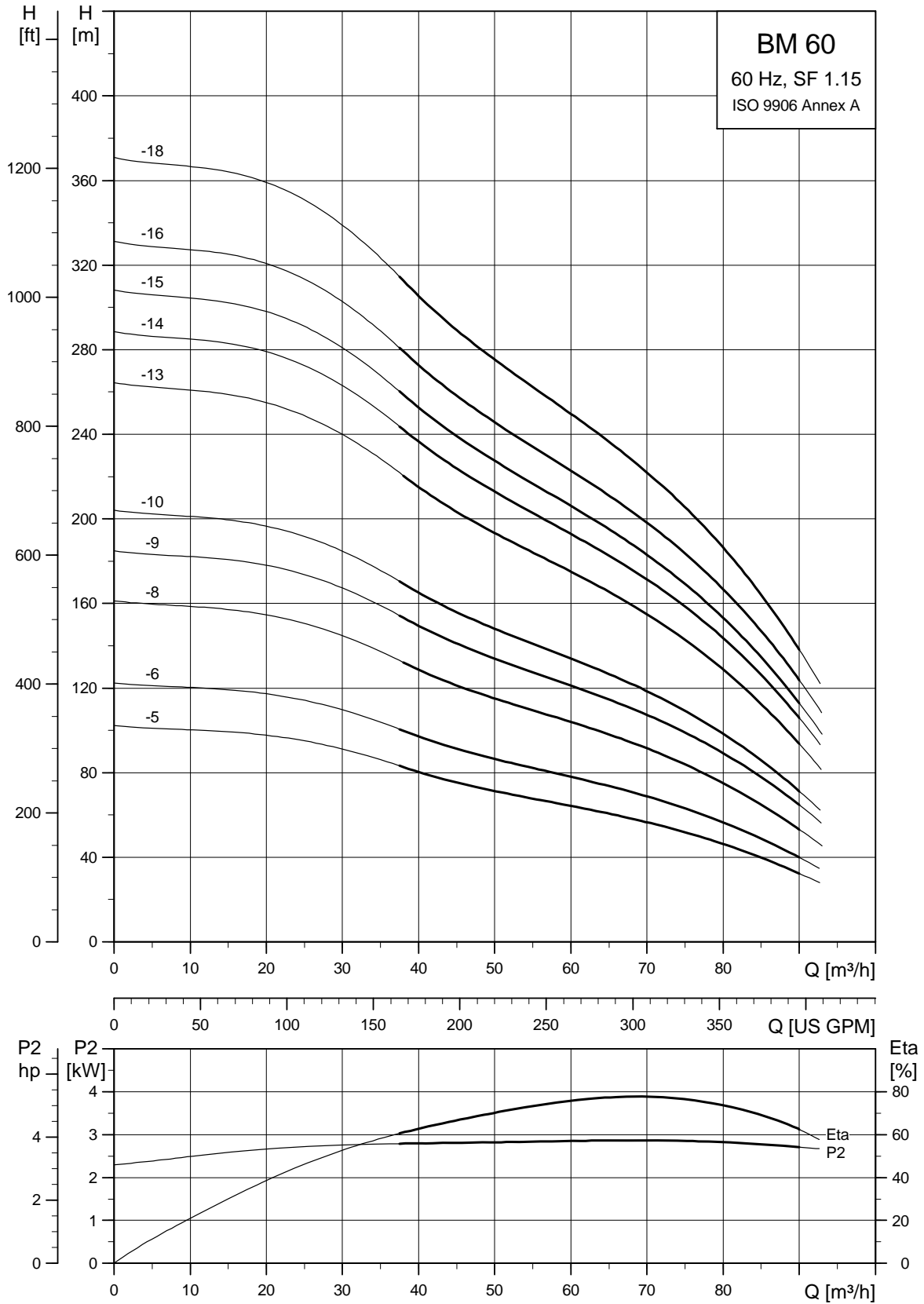

TM01 1226 3712

BM 77

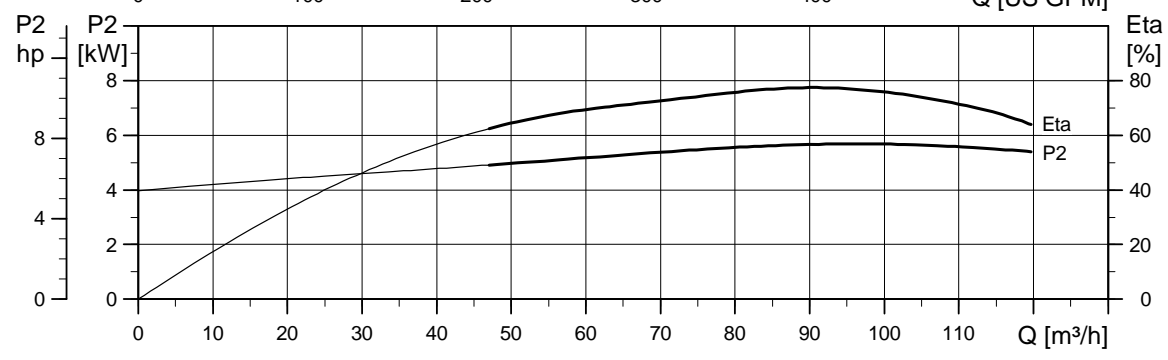
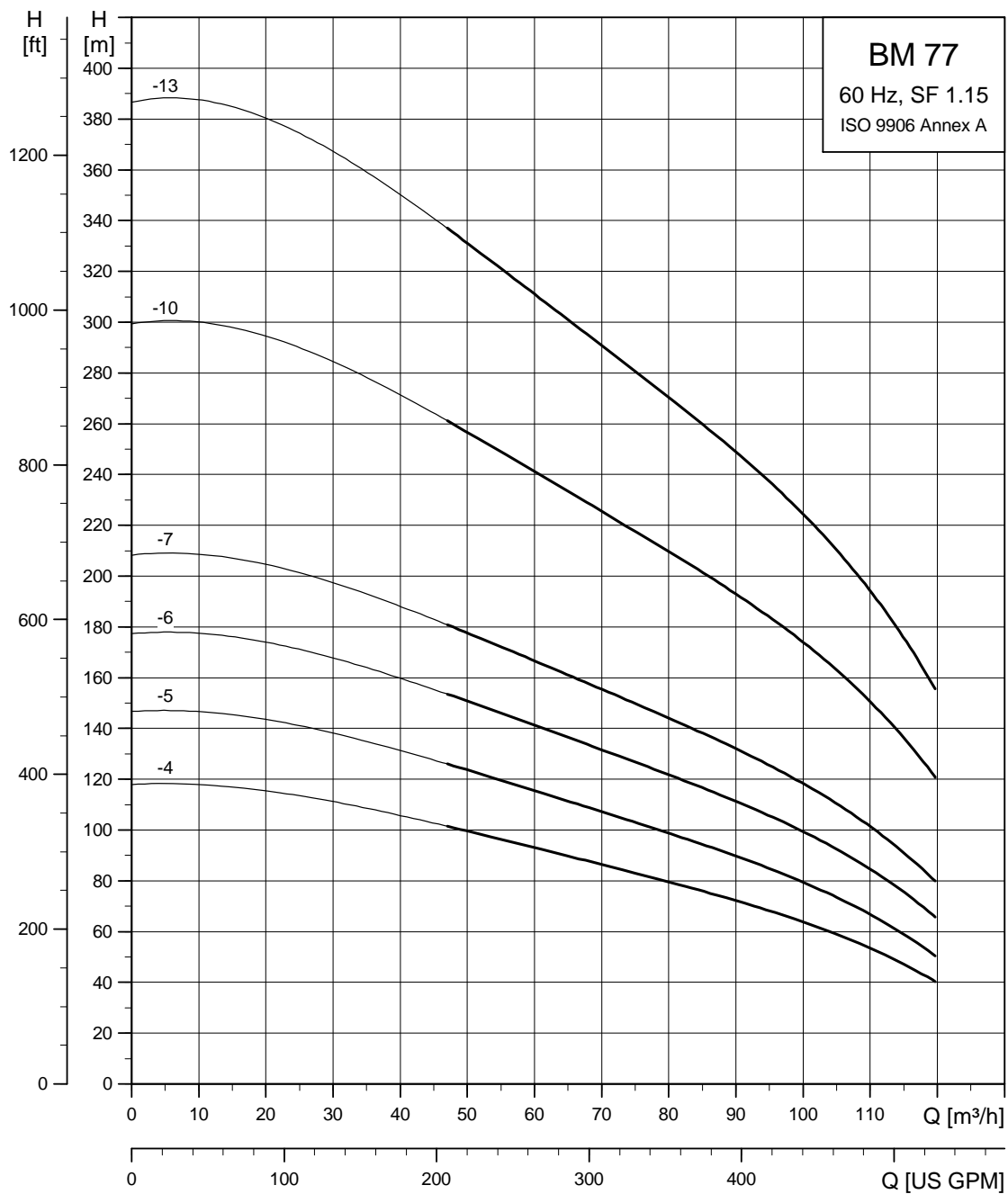

TM01 1227 3712

BM 95

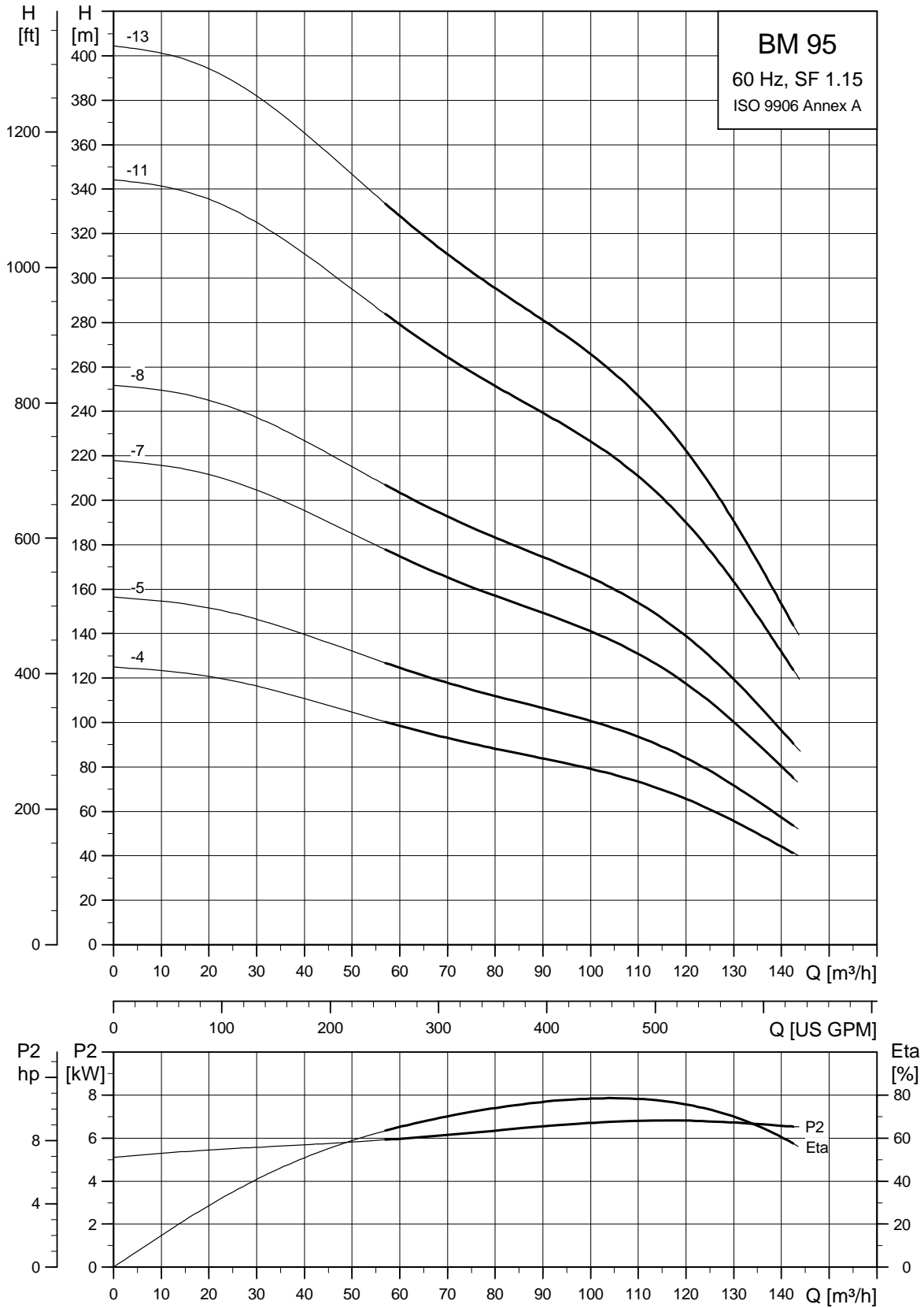

TM01 2079 3712

BM 125

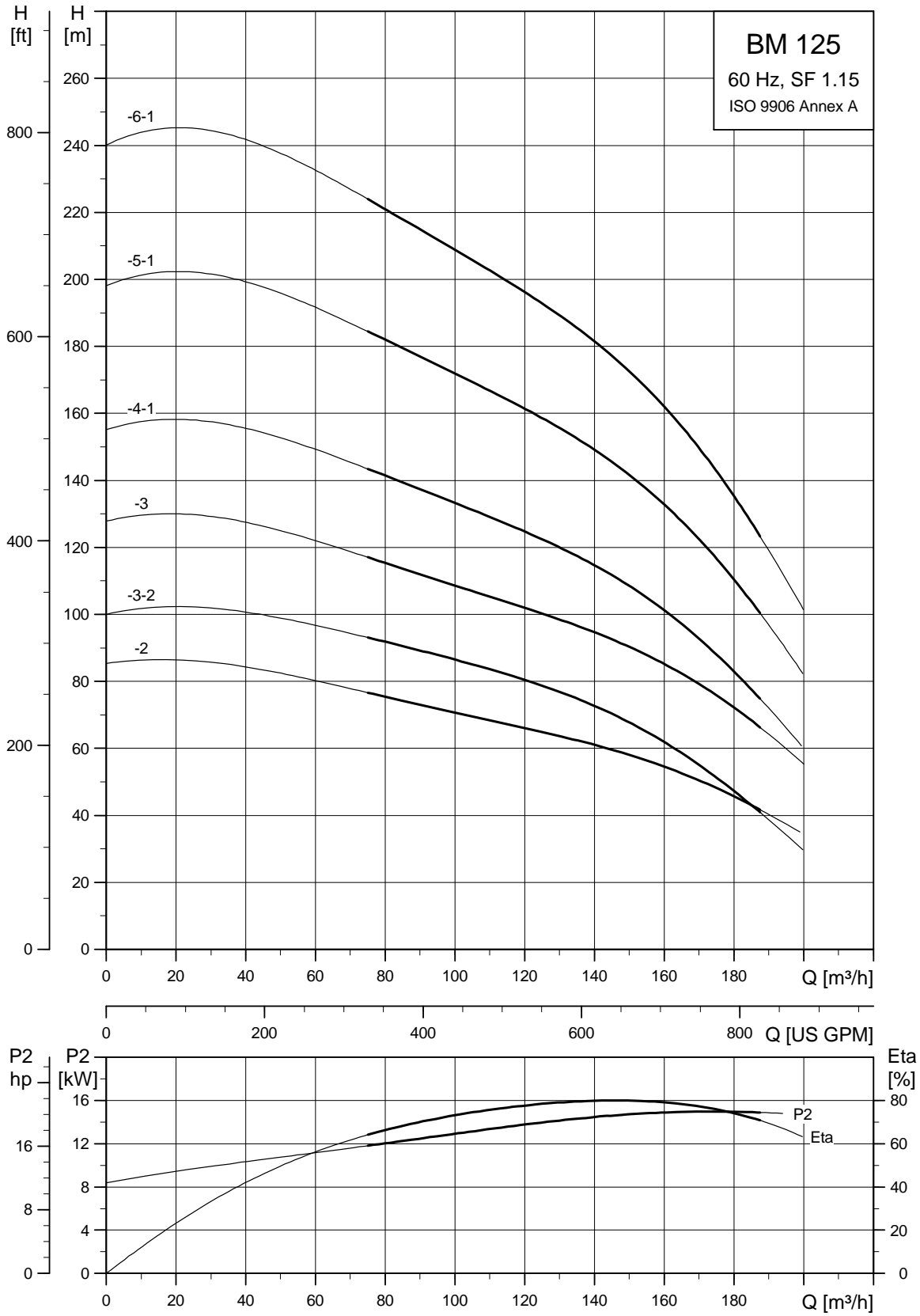

TM01 2080 3712

BM 160

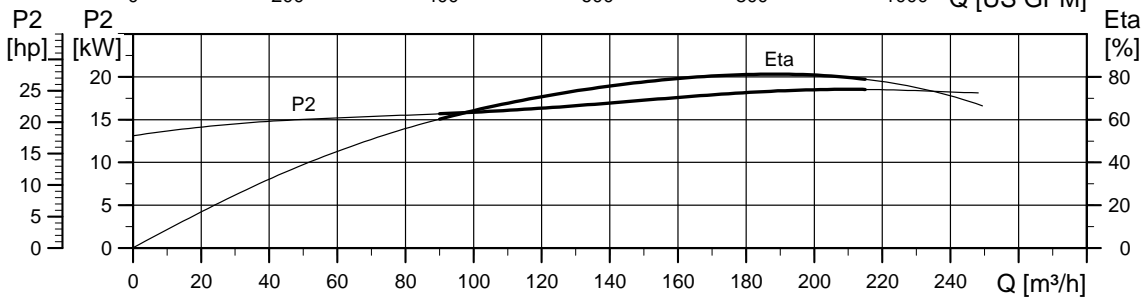
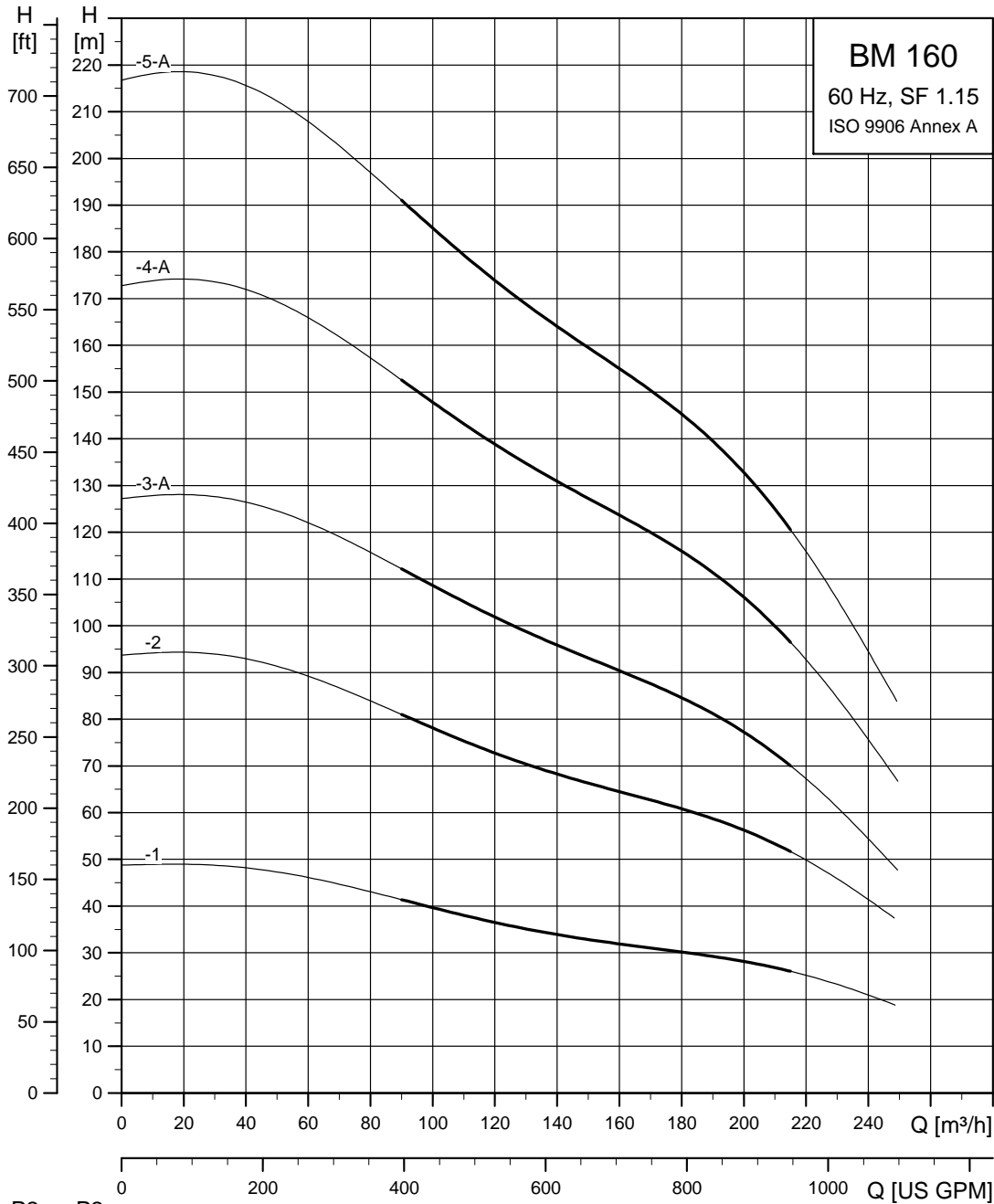

TM04 7952 3712

BM 215

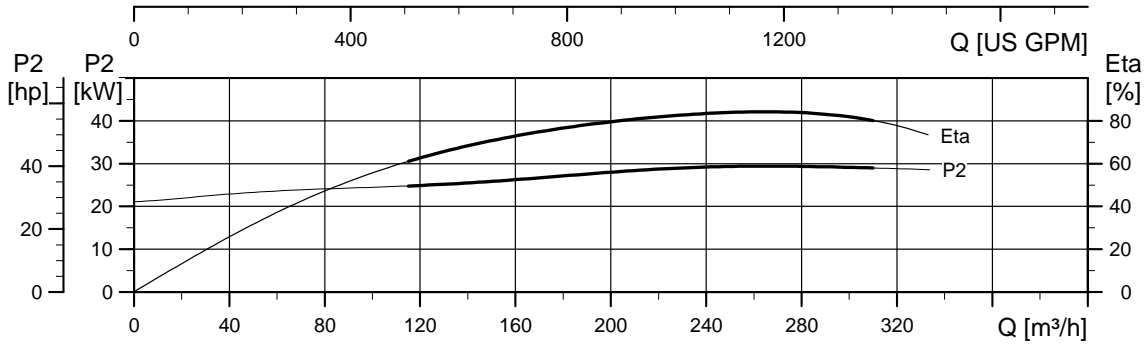
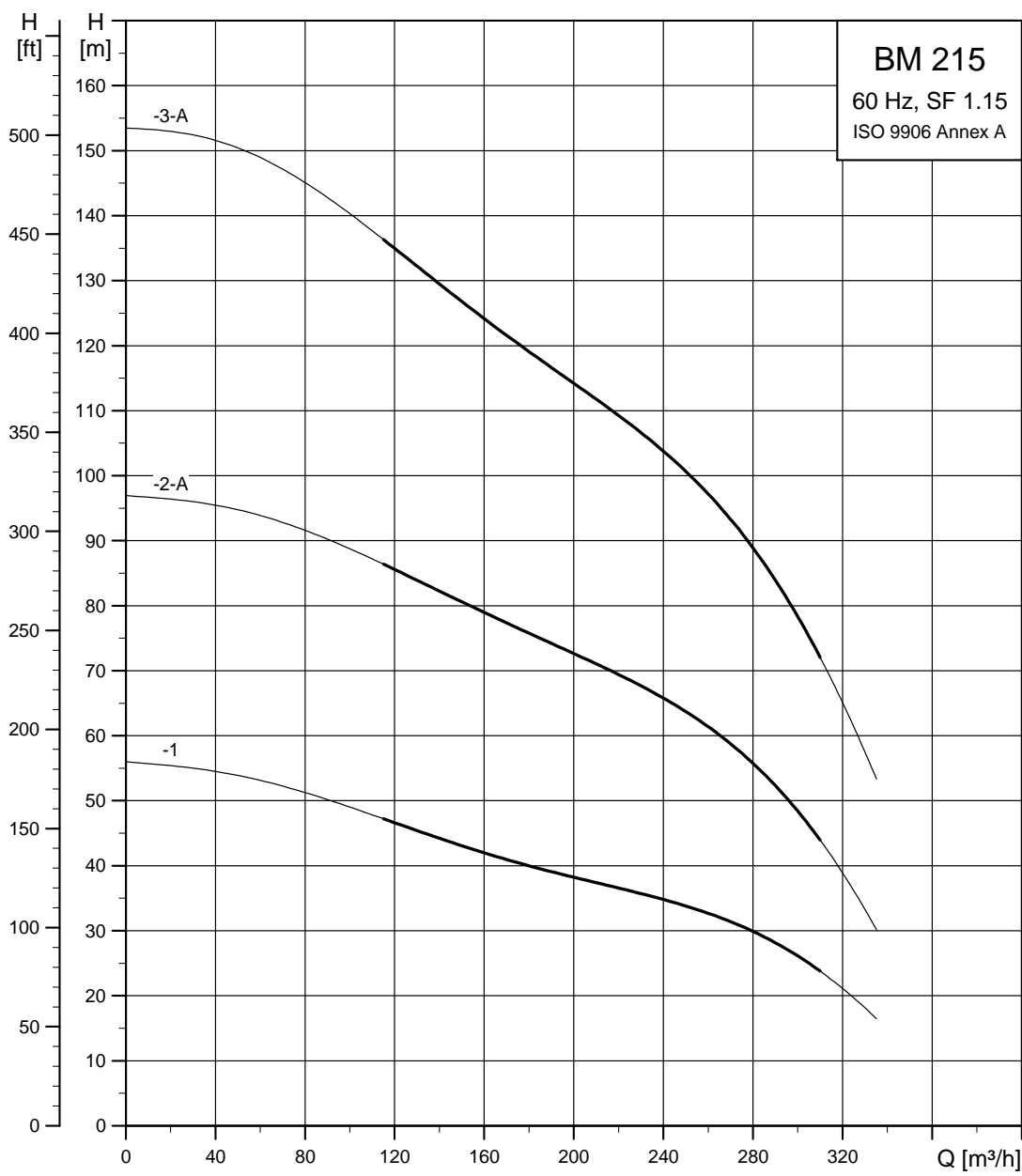

TM04 7954 3712

7. Order data, 60 Hz

BM 4" (with straight pipe)

Type	Motor output [P2]		Rated current I_N [A]	Length [L]		Product number				Weight [kg]		Ship. vol. [m ³]
	[kW]	[hp]		[mm]	[in]	1.4301	N version	NE version	R version	Net	Gross	
BM 3A-10	0.75	1.0	2.30 - 2.10	1222	48.1	10783610	10733610	10743610	-	32.0	38.0	0.123
BM 3A-14	1.1	1.5	3.05 - 2.95	1222	53.9	10783614	10733614	10743614	-	35.0	41.0	0.123
BM 3A-18	1.5	2.0	4.10 - 4.15	1369	53.9	10783618	10733618	10743618	-	37.0	43.0	0.136
BM 3A-24	2.2	3.0	5.65 - 6.05	1640	64.6	10783624	10733624	10743624	-	43.0	49.0	0.161
BM 3A-28	3.0	4.0	7.40 - 7.75	1640	64.6	10783628	10733628	10743628	-	45.0	51.0	0.161
BM 3A-32	4.0	5.5	9.45 - 9.45	1986	78.2	10783632	10733632	10743632	-	49.0	55.0	0.192
BM 3A-38	4.0	5.5	9.45 - 9.45	2112	83.1	10783638	10733638	10743638	-	56.0	63.0	0.204
BM 5A-5	0.75	1.0	2.30 - 2.10	1222	48.1	05783605	05733605	05743605	05773605	30.0	36.0	0.123
BM 5A-7	0.75	1.0	2.30 - 2.10	1222	48.1	05783607	05733607	05743607	05773607	31.0	37.0	0.123
BM 5A-9	1.1	1.5	3.05 - 2.95	1222	48.1	05783609	05733609	05743609	05773609	32.0	38.0	0.123
BM 5A-11	1.5	2.0	4.10 - 4.15	1222	48.1	05783611	05733611	05743611	05773611	33.0	39.0	0.123
BM 5A-15	2.2	3.0	5.65 - 6.05	1369	53.9	05783615	05733615	05743615	05773615	38.0	44.0	0.136
BM 5A-21	3.0	4.0	7.40 - 7.75	1640	64.6	05783621	05733621	05743621	05773621	42.0	48.0	0.161
BM 5A-26	4.0	5.5	9.45 - 9.45	1758	69.2	05783626	05733626	05743626	05773626	49.0	55.0	0.171
BM 5A-39	5.5	7.5	12.8 - 12.8	2112	83.1	05783639	05733639	05743639	05773639	60.0	67.0	0.204
BM 9-4	1.1	1.5	3.05 - 2.10	1222	48.1	98824053	98824058	98824063	98824068	33.0	39.0	0.123
BM 9-8	2.2	3.0	5.65 - 6.05	1472	58	98824054	98824059	98824064	98824069	42.0	48.0	0.145
BM 9-10	3.0	4.0	7.40 - 7.75	1758	69.2	98824055	98824060	98824065	98824070	45.0	51.0	0.171
BM 9-12	4.0	5.5	9.45 - 9.45	1986	78.2	98824056	98824061	98824066	98824071	51.0	57.0	0.192
BM 9-17	5.5	7.5	12.8 - 12.8	2346	92.4	98824057	98824062	98824067	98824072	62.0	68.0	0.225

On request, the BM is available in other voltages and with all stages indicated in the standard SP pump range.

Dimensional sketch

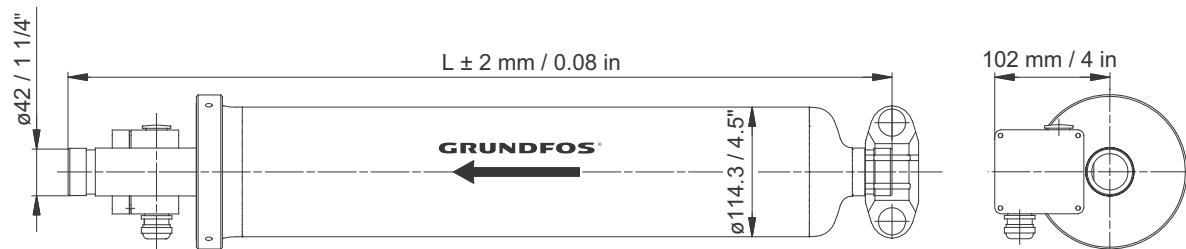

TM00 3797 0299

One set of connecting fittings is required for each system. See section *Accessories*, page 71.

BM 4" (with elbow)

Type	Motor output [P2]		Rated current I_N [A]	Length [L]		Product number				Weight [kg]		Ship. vol. [m ³]
	[kW]	[hp]		[mm]	[in]	1.4301	N version	NE version	R version	Net	Gross	
BM 3A-10	0.75	1.0	2.30 - 2.10	1144	45.0	10793610	10753610	10763610	-	32.0	38.0	0.115
BM 3A-14	1.1	1.5	3.05 - 2.95	1291	50.8	10793614	10753614	10763614	-	35.0	41.0	0.129
BM 3A-18	1.5	2.0	4.10 - 4.15	1291	50.8	10793618	10753618	10763618	-	37.0	43.0	0.129
BM 3A-24	2.2	3.0	5.65 - 6.05	1562	61.5	10793624	10753624	10763624	-	43.0	49.0	0.154
BM 3A-28	3.0	4.0	7.40 - 7.75	1562	61.5	10793628	10753628	10763628	-	45.0	51.0	0.154
BM 3A-32	3.0	4.0	7.40 - 7.75	1908	75.1	10793632	10753632	10763632	-	49.0	55.0	0.185
BM 3A-38	4.0	5.5	9.45 - 9.45	2034	80.1	10793638	10753638	10763638	-	56.0	63.0	0.196
BM 5A-5	0.75	1.0	2.30 - 2.10	1144	45.0	05793605	05753605	05763605	05723605	30.0	36.0	0.115
BM 5A-7	0.75	1.0	2.30 - 2.10	1144	45.0	05793607	05753607	05763607	05723607	31.0	37.0	0.115
BM 5A-9	1.1	1.5	3.05 - 2.95	1144	45.0	05793609	05753609	05763609	05723609	32.0	38.0	0.115
BM 5A-11	1.5	2.0	4.10 - 4.15	1144	45.0	05793611	05753611	05763611	05723611	33.0	39.0	0.115
BM 5A-15	2.2	3.0	5.65 - 6.05	1291	50.8	05793615	05753615	05763615	05723615	38.0	44.0	0.129
BM 5A-21	3.0	4.0	7.40 - 7.75	1562	61.5	05793621	05753621	05763621	05723621	42.0	48.0	0.154
BM 5A-26	4.0	5.5	9.45 - 9.45	1680	66.1	05793626	05753626	05763626	05723626	49.0	55.0	0.164
BM 5A-39	5.5	7.5	12.8 - 12.8	2034	80.1	05793639	05753639	05763639	05723639	60.0	67.0	0.196
BM 9-4	1.1	1.5	3.05 - 2.10	1144	45	98824073	98824078	98824083	98824088	33.0	39.0	0.115
BM 9-8	2.2	3.0	5.65 - 6.05	1394	54.9	98824074	98824079	98824084	98824089	42.0	48.0	0.138
BM 9-10	3.0	4.0	7.40 - 7.75	1680	66.1	98824075	98824080	98824085	98824090	45.0	51.0	0.164
BM 9-12	4.0	5.5	9.45 - 9.45	1908	75.1	98824076	98824081	98824086	98824091	51.0	57.0	0.185
BM 9-17	5.5	7.5	12.8 - 12.8	2268	89.3	98824077	98824082	98824087	98824092	62.0	68.0	0.218

On request, the BM is available in other voltages, with all stages indicated in the standard SP pump range and in R version.

Dimensional sketch

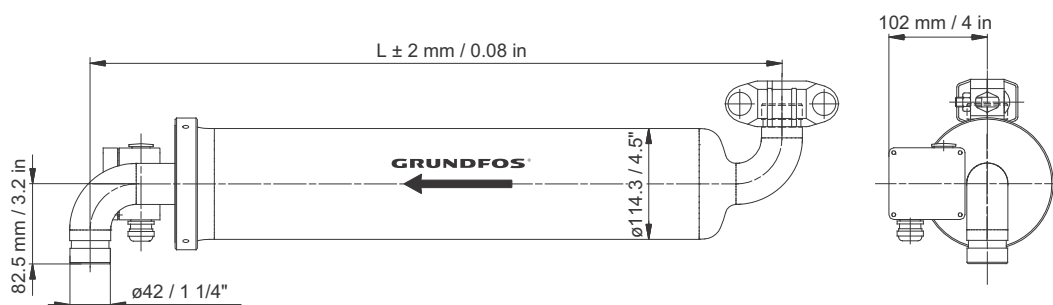

TM00 3798 0299

One set of connecting fittings is required for each system. See section *Accessories*, page 71.

BM 6" (with straight pipe)

Type	Motor output [P2]		Rated current I_N [A]	Length [L]		Product number				Weight [kg]		Ship. vol. [m ³]
	[kW]	[hp]		[mm]	[in]	1.4301	N version	NE version	R version	Net	Gross	
BM 17-3	3.0	4.0	7.40 - 7.75	1550	61.0	98490818	12DJ3603	12DH3603	12DU3603	48.0	69.0	0.273
BM 17-4	4.0	5.5	9.45 - 9.45	1550	61.0	98490819	12DJ3604	12DH3604	12DU3604	53.0	76.0	0.273
BM 17-6	5.5	7.5	12.8 - 12.8	1850	72.8	98490820	12DJ3606	12DH3606	12DU3606	63.0	90.0	0.320
BM 17-8	7.5	10	17.4 - 17.0	1850	72.8	98490821	12DJ3608	12DH3608	12DU3608	79.0	113.0	0.320
BM 17-10	9.2	12.5	21.80 - 21.0	2100	82.7	98490822	12DJ3610	12DH3610	12DU3610	91.0	129.0	0.356
BM 17-12	11	15	25.5 - 24.0	2200	86.6	98490823	12DJ3612	12DH3612	12DU3612	97.0	138.0	0.374
BM 17-15	13	17.5	29.5 - 28.5	2500	98.4	98490824	12DJ3615	12DH3615	12DU3615	109.0	155.0	0.421
BM 17-17	15	20	33.5 - 32.5	2500	98.4	98490825	12DJ3617	12DH3617	12DU3617	115.0	163.0	0.421
BM 17-21	18.5	25	42.0 - 41.0	2850	112.2	98490826	12DJ3621	12DH3621	12DU3621	131.0	185.0	0.476
BM 17-25	22	30	48.0 - 46.5	3200	126.0	98490827	12DJ3625	12DH3625	12DU3625	147.0	208.0	0.530
BM 17-30	26	35	57.5 - 54.5	3800	149.6	98490828	12DJ3630	12DH3630	12DU3630	167.0	236.0	0.624
BM 30-2	3.0	4.0	7.40 - 7.75	1550	61.0	98490829	13DJ3602	13DH3602	13DU3602	47.0	68.0	0.273
BM 30-3	4.0	5.5	9.45 - 9.45	1650	65.0	98490830	13DJ3603	13DH3603	13DU3603	54.0	78.0	0.289
BM 30-4	5.5	7.5	12.8 - 12.8	1850	72.8	98490831	13DJ3604	13DH3604	13DU3604	64.0	92.0	0.320
BM 30-5	7.5	10	17.4 - 17.0	1850	72.8	98490832	13DJ3605	13DH3605	13DU3605	78.0	111.0	0.320
BM 30-7	9.2	12.5	21.8 - 21.0	2100	82.7	98490833	13DJ3607	13DH3607	13DU3607	91.0	129.0	0.356
BM 30-8	11	15	25.5 - 24.0	2200	86.6	98490834	13DJ3608	13DH3608	13DU3608	96.0	136.0	0.374
BM 30-10	13	17.5	29.5 - 28.5	2500	98.4	98490835	13DJ3610	13DH3610	13DU3610	108.0	153.0	0.421
BM 30-11	15	20	33.5 - 32.5	2500	98.4	98490836	13DJ3611	13DH3611	13DU3611	113.0	160.0	0.421
BM 30-14	18.5	25	42.0 - 41.0	2850	112.2	98490837	13DJ3614	13DH3614	13DU3614	129.0	183.0	0.476
BM 30-17	22	30	48.0 - 46.5	3200	126.0	98490838	13DJ3617	13DH3617	13DU3617	145.0	205.0	0.530
BM 30-20	26	35	57.5 - 54.5	3800	149.6	98490839	13DJ3620	13DH3620	13DU3620	165.0	233.0	0.624
BM 30-23	30	40	66.5 - 63.0	4250	167.3	98490840	13DJ3623	13DH3623	13DU3623	185.0	261.0	0.694
BM 46-2	5.5	7.5	12.8 - 12.8	1650	65.0	98490841	15E03602	15E13602	15E63602	59.0	85.0	0.289
BM 46-3	7.5	10	17.4 - 17.0	1750	68.9	98490842	15E03603	15E13603	15E63603	75.0	107.0	0.304
BM 46-4	9.2	12.5	21.8 - 21.0	1850	72.8	98490843	15E03604	15E13604	15E63604	85.0	121.0	0.320
BM 46-5	13	17.5	29.5 - 28.5	2100	82.7	98490844	15E03605	15E13605	15E63605	98.0	139.0	0.356
BM 46-6	15	20	33.5 - 32.5	2200	86.6	98490845	15E03606	15E13606	15E63606	105.0	149.0	0.374
BM 46-8	18.5	25	42.0 - 41.0	2500	98.4	98490846	15E03608	15E13608	15E63608	121.0	171.0	0.421
BM 46-9	22	30	48.0 - 46.5	2700	106.3	98490847	15E03609	15E13609	15E63609	132.0	187.0	0.452
BM 46-11	26	35	57.5 - 54.5	3050	120.0	98490848	15E03611	15E13611	15E63611	148.0	209.0	0.507
BM 46-13	30	40	66.5 - 63.0	3200	126.0	98490849	15E03613	15E13613	15E63613	163.0	230.0	0.530
BM 60-5	15	20	33.5 - 32.5	2100	82.7	98490850	14DE3605	14DJ3605	14E63605	102.0	145.0	0.356
BM 60-6	18.5	25	42.0 - 41.0	2200	86.6	98490851	14DE3606	14DJ3606	14E63606	111.0	157.0	0.374
BM 60-8	22	30	48.0 - 46.5	2500	98.4	98490852	14DE3608	14DJ3608	14E63608	127.0	180.0	0.421
BM 60-9	26	35	57.5 - 54.5	2700	106.3	98490853	14DE3609	14DJ3609	14E63609	138.0	195.0	0.452
BM 60-10	30	40	66.5 - 63.0	2850	112.2	98490854	14DE3610	14DJ3610	14E63610	150.0	212.0	0.476

On request, the BM is available in other voltages and with all stages indicated in the standard SP pump range.

Dimensional sketch

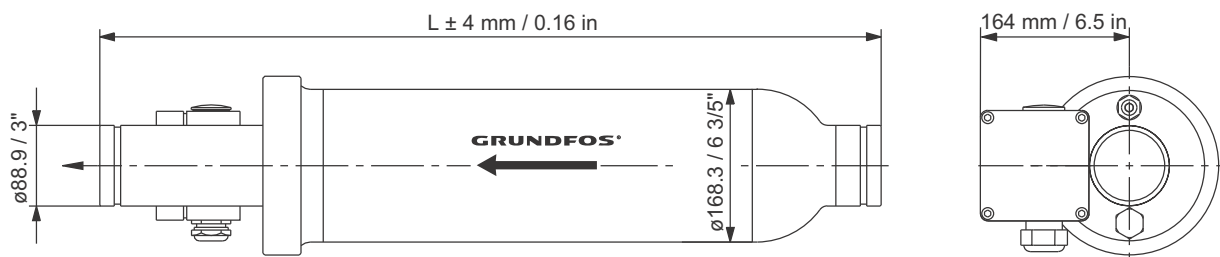

TM00 3799 4312

One set of connecting fittings is required for each system. See section *Accessories*, page 71.

BM 8" (with straight pipe)

Type	Motor output [P2]		Rated current I_N [A]	Length [L]		Product number				Weight [kg]		Ship. vol. [m ³]
	[kW]	[hp]		[mm]	[in]	1.4301	N version	NE version	R version	Net	Gross	
BM 30-27*	37	50	78.0	4450	175.2	13DS3627	13DK3627	13DW3627	13CU3627	322	420	1.65
BM 46-16*	37	50	78.0	3800	149.6	15DS3616	15DK3616	15DW3616	15CU3616	307	391	1.42
BM 46-19*	45	60	92.5	4150	163.4	15DS3619	15DK3619	15DW3619	15CU3619	341	433	1.54
BM 60-13*	37	50	78.0	3450	135.8	14DS3613	14DK3613	14DW3613	14CU3613	291	367	1.29
BM 60-14*	45	60	92.5	3800	149.6	14DS3614	14DK3614	14DW3614	14CU3614	323	407	1.42
BM 60-15*	45	60	92.5	3800	149.6	14DS3615	14DK3615	14DW3615	14CU3615	324	408	1.42
BM 60-16*	55	75	112	4150	163.4	14DS3616	14DK3616	14DW3616	14CU3616	348	439	1.54
BM 60-18*	55	75	112	4150	163.4	14DS3618	14DK3618	14DW3618	14CU3618	353	444	1.54
BM 77-4	22	30	48.0 - 46.5	2400	94.5	16DS3604	16DE3604	16DJ3604	16CU3604	170	223	0.91
BM 77-5	30	40	66.5 - 63.0	2750	108.3	16DS3605	16DE3605	16DJ3605	16CU3605	194	254	1.04
BM 77-6*	37	50	78.0	3200	126.0	16DS3606	16DK3606	16DW3606	16CU3606	287	257	1.20
BM 77-7*	45	60	92.5	3200	126.0	16DS3607	16DK3607	16DW3607	16CU3607	311	381	1.20
BM 77-10*	55	75	112	3800	149.6	16DS3610	16DK3610	16DW3610	16CU3610	351	434	1.42
BM 77-13*	75	100	150	4150	163.4	16DS3613	16DK3613	16DW3613	16CU3613	414	505	1.54
BM 95-4	26	35	57.5 - 54.5	2400	94.5	19DS3604	19893604	19903604	19913604	176	228	0.91
BM 95-5*	37	50	78.0	2750	108.3	19DS3605	19913605	19923604	19933605	273	333	1.04
BM 95-7*	45	60	92.5	3200	126.0	19DS3607	19913607	19923607	19933607	311	381	1.20
BM 95-8*	55	75	112	3450	126.0	19DS3608	19913608	19923608	19933608	335	410	1.20
BM 95-11*	75	100	150	4150	163.4	19DS3611	19913611	19923611	19933611	406	497	1.54
BM 95-13*	92.0	123.0	184	4450	175.2	19DS3613	19913613	19923613	19933613	466	563	1.65
BM 125-2	30	40	66.5 - 63.0	2400	94.5	17DS3602	17DR3602	17DT3602	17CU3602	192	245	0.91
BM 125-3-AA*	37	50	78.0	2750	108.3	17DS36B3	17DU36B3	17DW36B3	17CU36B3	283	343	1.05
BM 125-3*	45	50	92.5	2750	108.3	17DS3603	17DU3603	17DW3603	17CU3603	306	367	1.04
BM 125-4-A*	55	75	112	3200	126.0	17DS36A4	17DU36A4	17DW36A4	17CU36A4	337	407	1.20
BM 125-5-A*	75	100	150	3800	149.6	17DS36A5	17DU36A5	17DW36A5	17CU36A5	399	482	1.42
BM 125-6-A*	92.0	123.0	184	3800	149.6	17DS36A6	17DU36A6	17DW36A6	17CU36A6	451	535	1.42
BM 160-1	22	30	48.0 - 46.5	2400	94.5	20DS3601	20DK3601	20DW3601	20CU3601	172	225	0.91
BM 160-2*	37	50	78	2750	108.3	20DS3602	20DK3602	20DW3602	20CU3602	277	338	1.04
BM 160-3-A*	55	75	112	3200	126.0	20DS36A3	20DK36A3	20DW36A3	20CU36A3	331	401	1.20
BM 160-4-A*	75	100	150	3200	126.0	20DS36A4	20DK36A4	20DW36A4	20CU36A4	380	450	1.20
BM 160-5-A*	92	125	184	3800	149.6	20DS36A5	20DK36A5	20DW36A5	20CU36A5	445	529	1.42
BM 215-1	30	40	66.5 - 63	2400	94.5	18DS3601	18DK3601	18DW3601	18CU3601	193	246	0.91
BM 215-2-A*	55	75	112	3200	126.0	18DS36A2	18DK36A2	18DW36A2	18CU36A2	336	406	1.20
BM 215-3-A*	92	125	184	3800	149.6	18DS36A3	18DK36A3	18DW36A3	18CU36A3	450	534	1.42

On request, the BM is available in other voltages and with all stages indicated in the standard SP pump range.

* Full-load current I_{SF} applies to 3 x 460 V.

Connections

Size	Type	Victaulic coupling, style 77
BM 8"	BM 30 - BM 46	3" / Ø89
BM 8"	BM 60	4" / Ø114
BM 8"	BM 77 - BM 95	5" / Ø139
BM 8"	BM 125 - BM 215	6" / Ø168

Dimensional sketch

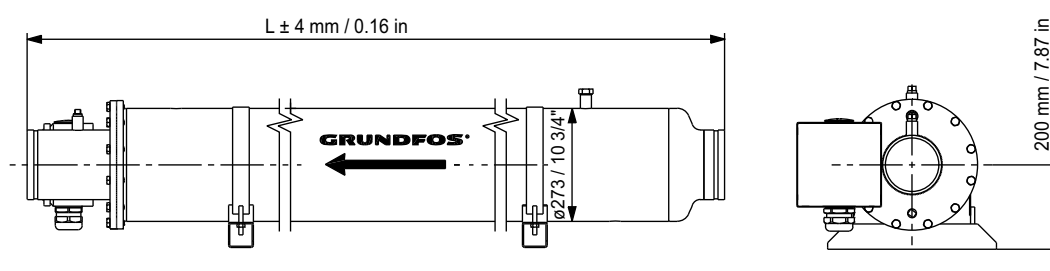

TM01 1424 3812

One set of connecting fittings is required for each system. See section *Accessories*, page 71.

8. General description, BMhp

Applications

The Grundfos BMhp booster module is suitable for industrial and water supply applications where the inlet pressure is high, i.e. 60 to 80 bar. BMhp booster modules are used to increase the system pressure up to 80 bar.

The BMhp booster module is the optimum solution for applications requiring the following:

- sealless pumps
- pumps capable of coping with high system pressures
- high heads
- quiet operation
- a minimum of maintenance.

Typical applications

BMhp booster modules are suitable for the following typical applications:

- water treatment where energy recovery devices (ERD), like pressure exchangers are used, such as:
 - reverse osmosis in domestic water supply systems
 - hospitals, laboratories as well as chemical, electronics and metal industries
 - ultra-filtration in chemical and galvanic industries
 - painting workshops, metal and mineral industries
- liquid transfer
- pressure boosting
- closed circulation systems with a high static pressure.

Feature

BMhp booster modules need no flushing during continuous operation due to an internal by-pass.

Standard pumps

The following standard pumps are available for the BMhp booster modules:

- SP 17, SP 30, SP 46 and SP 60 in 6" sleeve
- SP 77, SP 95, SP 125, SP 160 and SP 215 in 8" sleeve.

Note: The BMhp booster modules are supplied without non-return valves.

Pumped liquids

Thin, non-explosive liquids not containing abrasive particles or fibres. The liquid must not attack the pump materials chemically or mechanically.

If the density and/or viscosity of the pumped liquid is higher than that of water, it may be necessary to use motors with a higher output than the standard output stated.

Construction

Modified standard submersible pumps are used for the BMhp booster modules. Pump and motor are centred in the stainless-steel (Duplex) sleeve.

Both sleeve ends can be connected to the piping by means of Victaulic couplings.

A terminal box for electrical connection is located at the discharge end.

The sleeve of 6" and 8" modules is supplied with straight pipe inlet and outlet.

Motor

Asynchronous submersible squirrel-cage motor of the canned type with water-lubricated bearings.

Voltages

- 3 x 380-415 V - 10 %/+ 6 %
- 3 x 440-480 V - 10 %/+ 6 %.

Enclosure class

- IP58 (MMS 8000)
- IP68 (MS 6000).

Insulation class

MMS wet-wound with PE/PA winding wires.

Special versions

Voltages up to 1000 V available on request.

Operating conditions

Flow rate

- 50 Hz: Max. 265 m³/h, 1166 US gpm
- 60 Hz: Max. 310 m³/h, 1364 US gpm.

Temperature

Max. 30 °C / 86 °F.

Contact Grundfos in case of higher temperature.

Outlet pressure

Max. 80 bar / 1160 psi.

Recommended inlet pressure at 25 °C / 77 °F

BMhp	Min.		Max.	
	[bar]	[psi]	[bar]	[psi]
6"	0.5	7.25	80	1160
8"	1	14.5	80	1160

Rated speed

- 50 Hz: 2870 min⁻¹
- 60 Hz: 3450 min⁻¹.

Sound pressure level

- The sound pressure level of BMhp 6" booster modules is below 70 dB(A).
- The sound pressure level of BMhp 8" booster modules is below 80 dB(A).

See also section *Limitations to operation*, page 12.

Types and versions

BMhp 6"

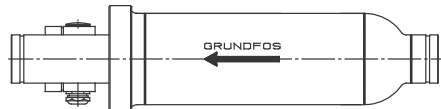

TM00 4019 2410

BMhp 8"

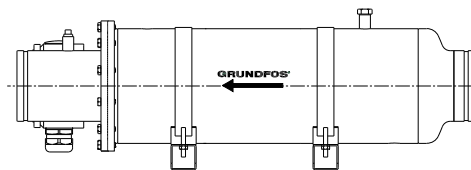

TM01 1420 1912

Sectional drawings

BMhp 6"

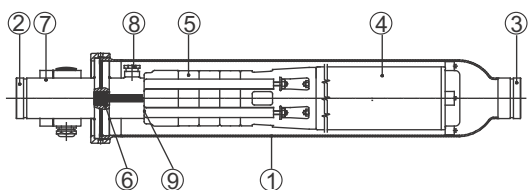

TM00 3796 2410

BMhp 8"

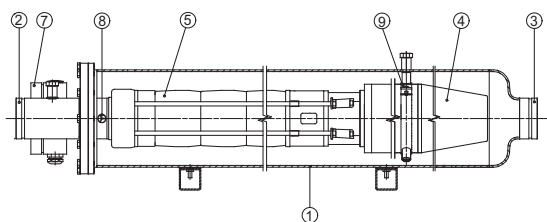

TM01 1419 1912

1. Sleeve
2. Discharge connection
3. Suction connection
4. Submersible motor
5. Submersible pump
6. Cable inlet
7. Terminal box
8. Inlet bypass valve
9. Locking system for BMhp 8".
BMhp 6" has a left-hand thread for locking.

9. Performance curves, 50 Hz

BMhp 17

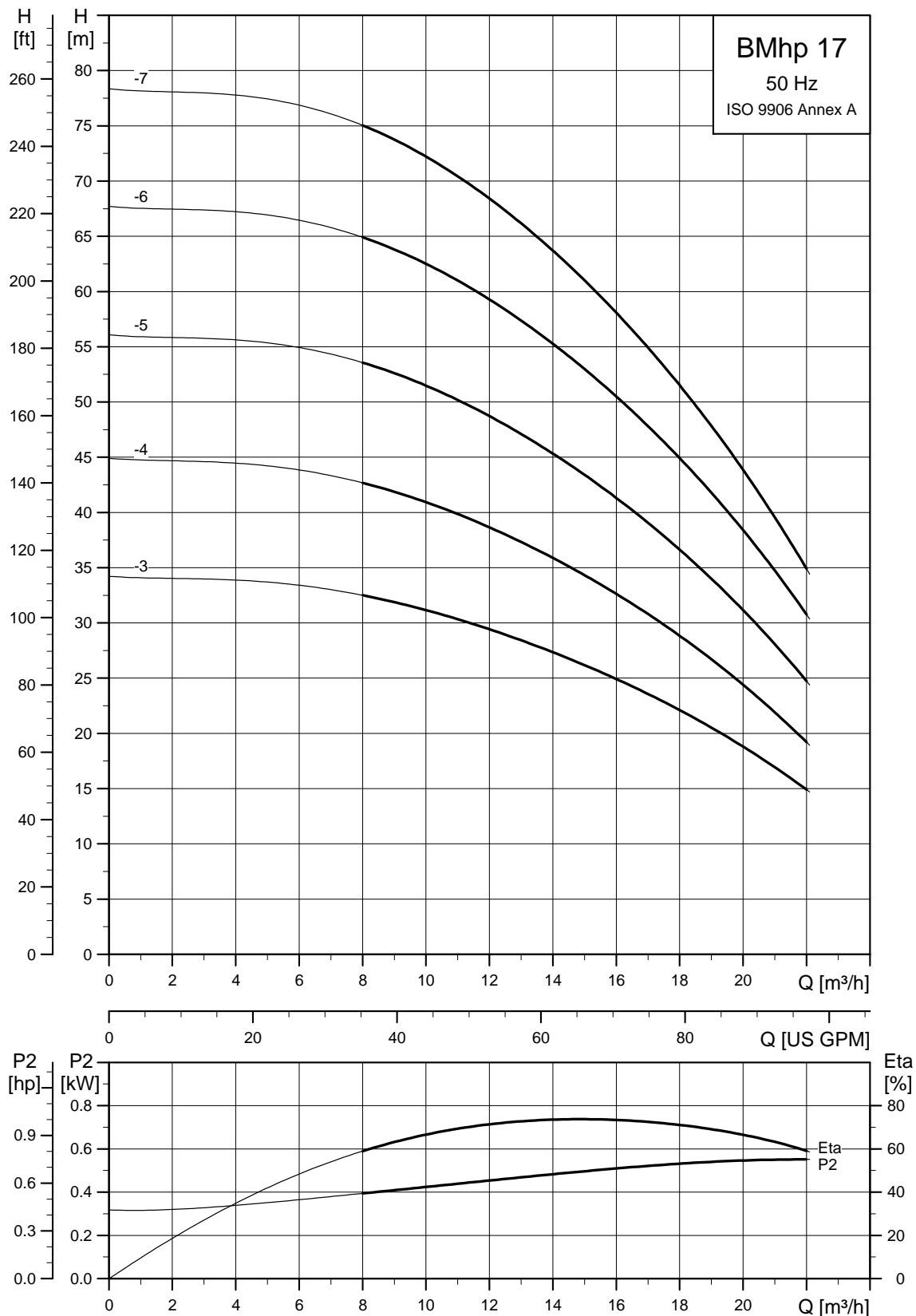

TM04 7955 3712

BMhp 30

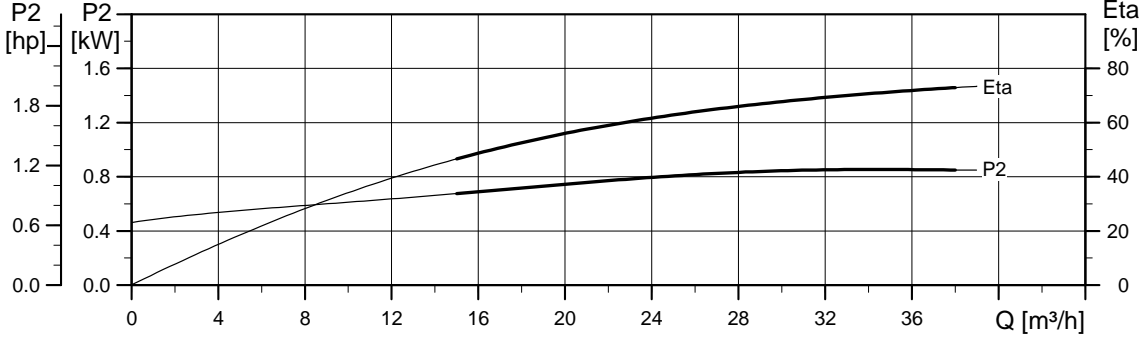
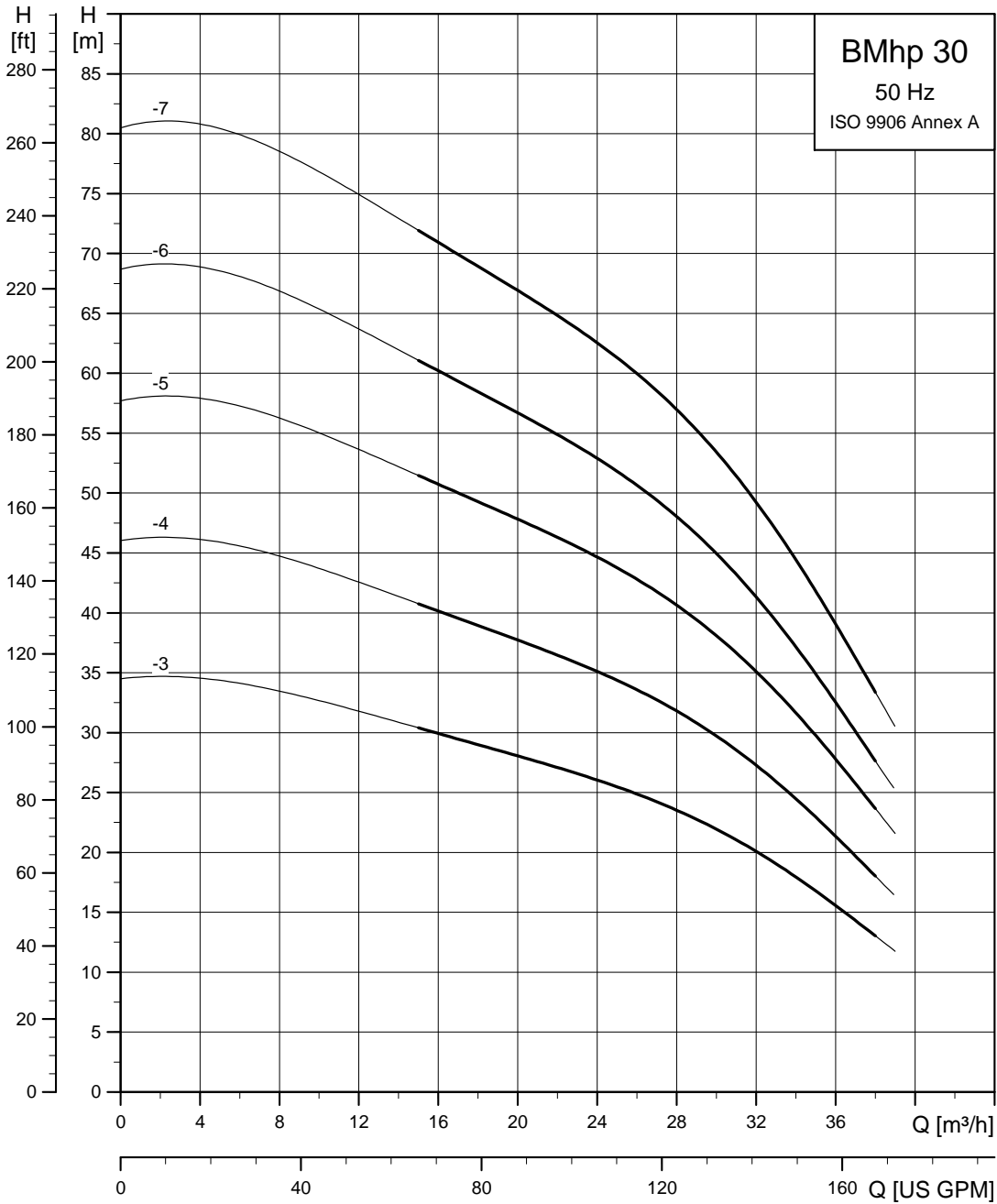

TM04 7956 2510

BMhp 46

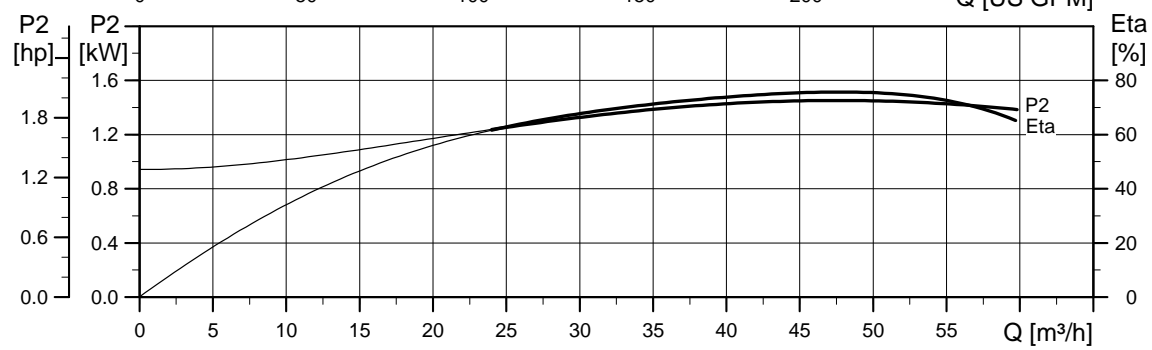
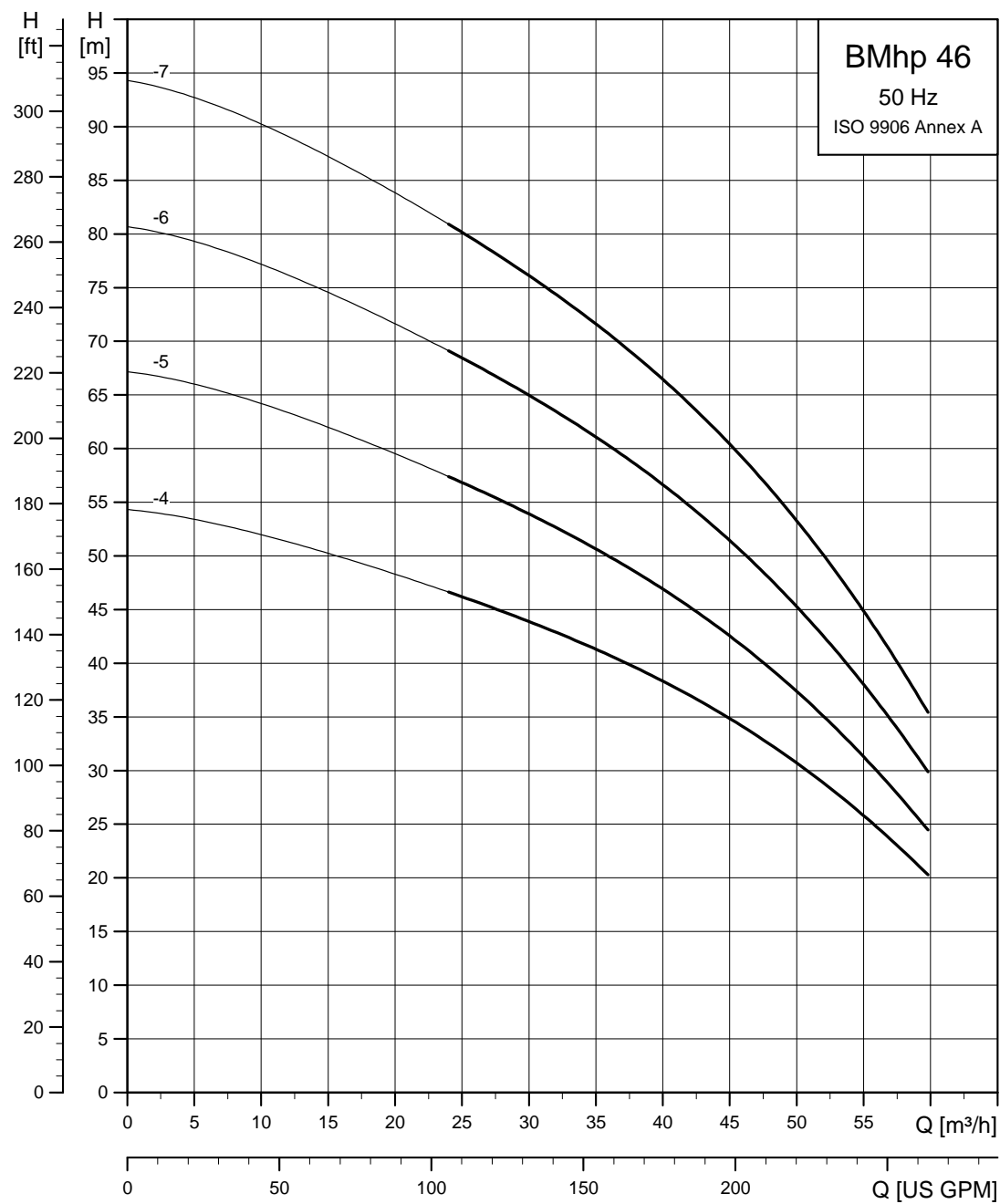

TM04 7957 3712

BMhp 60

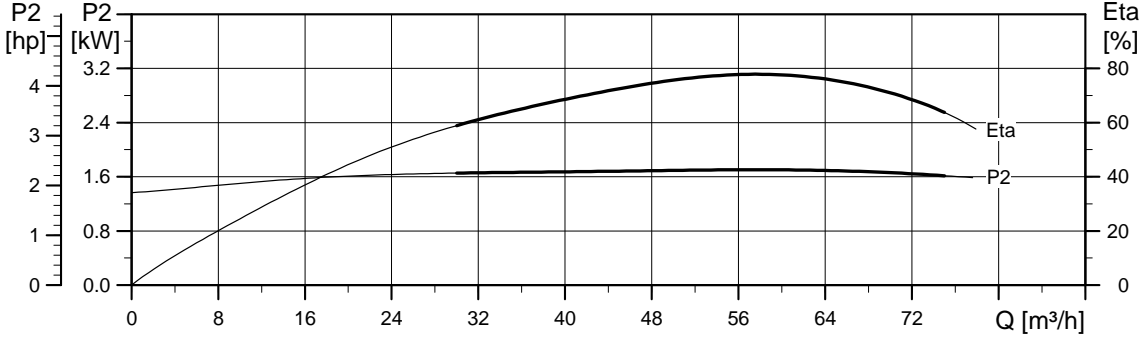
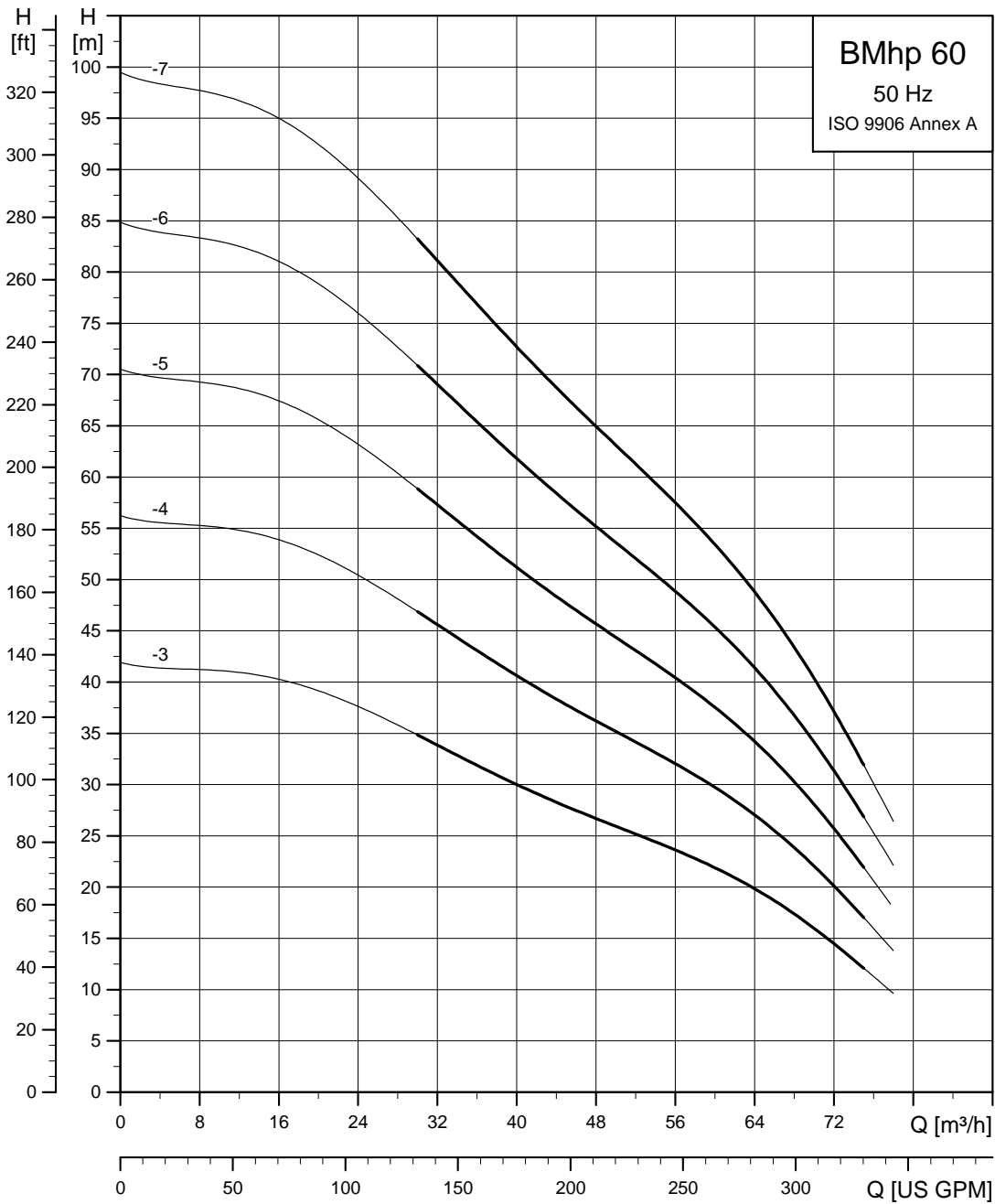

TM04 7958 3712

BMhp 77

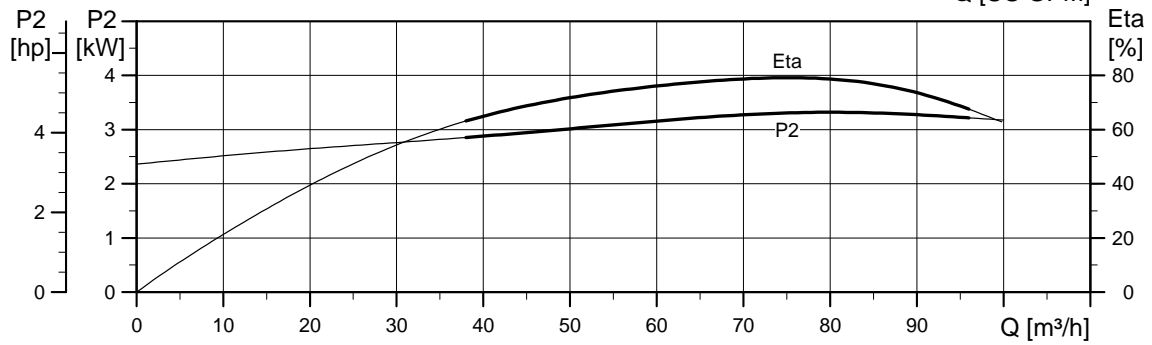
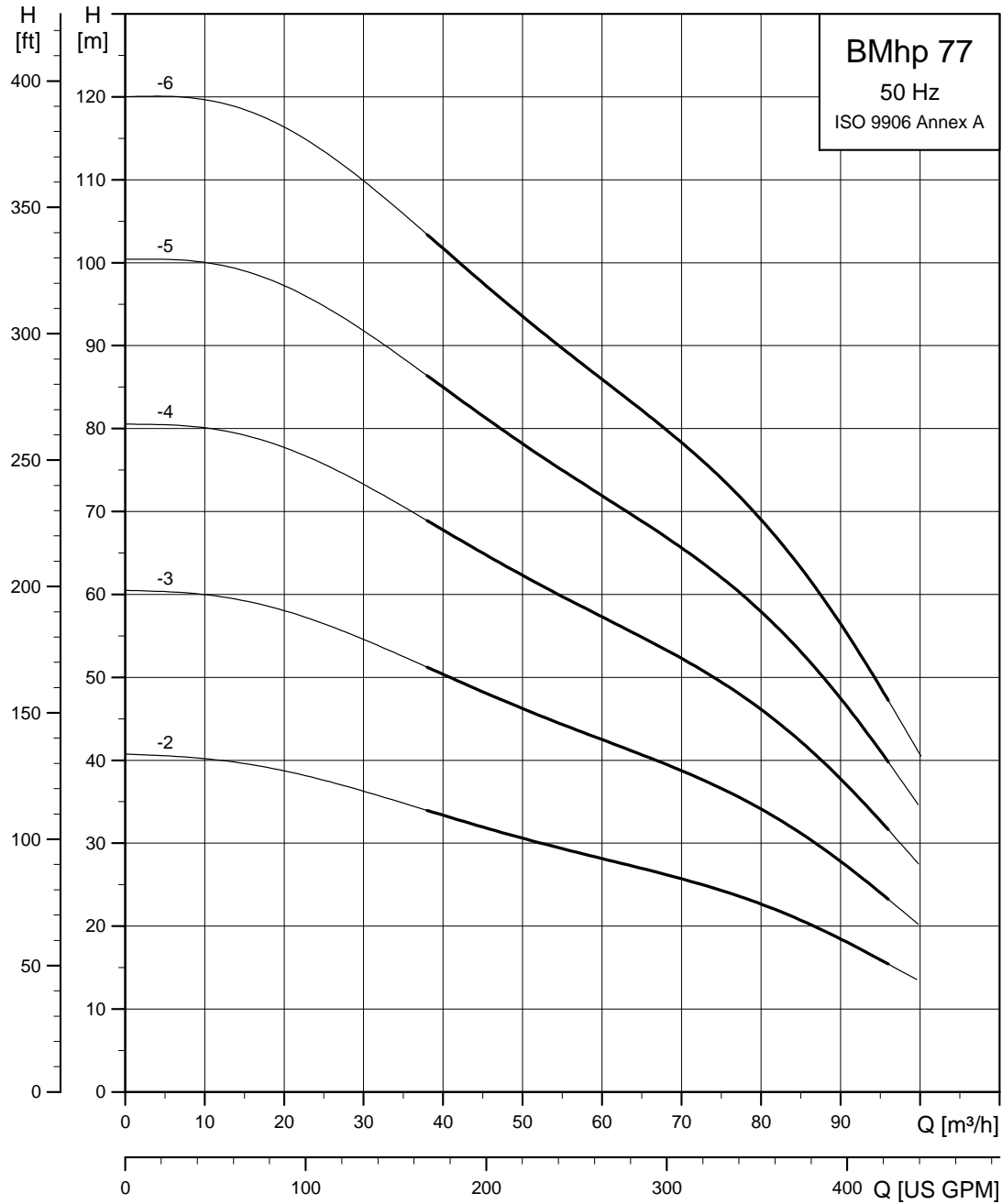

TM04 7959 3712

BMhp 95

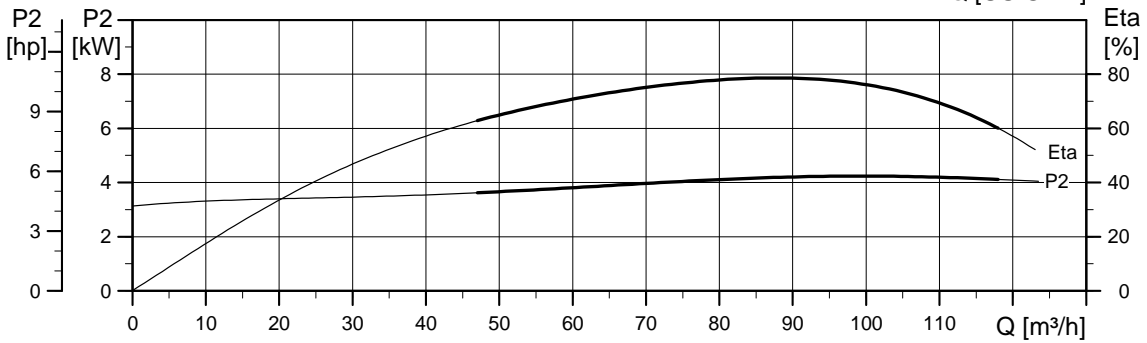
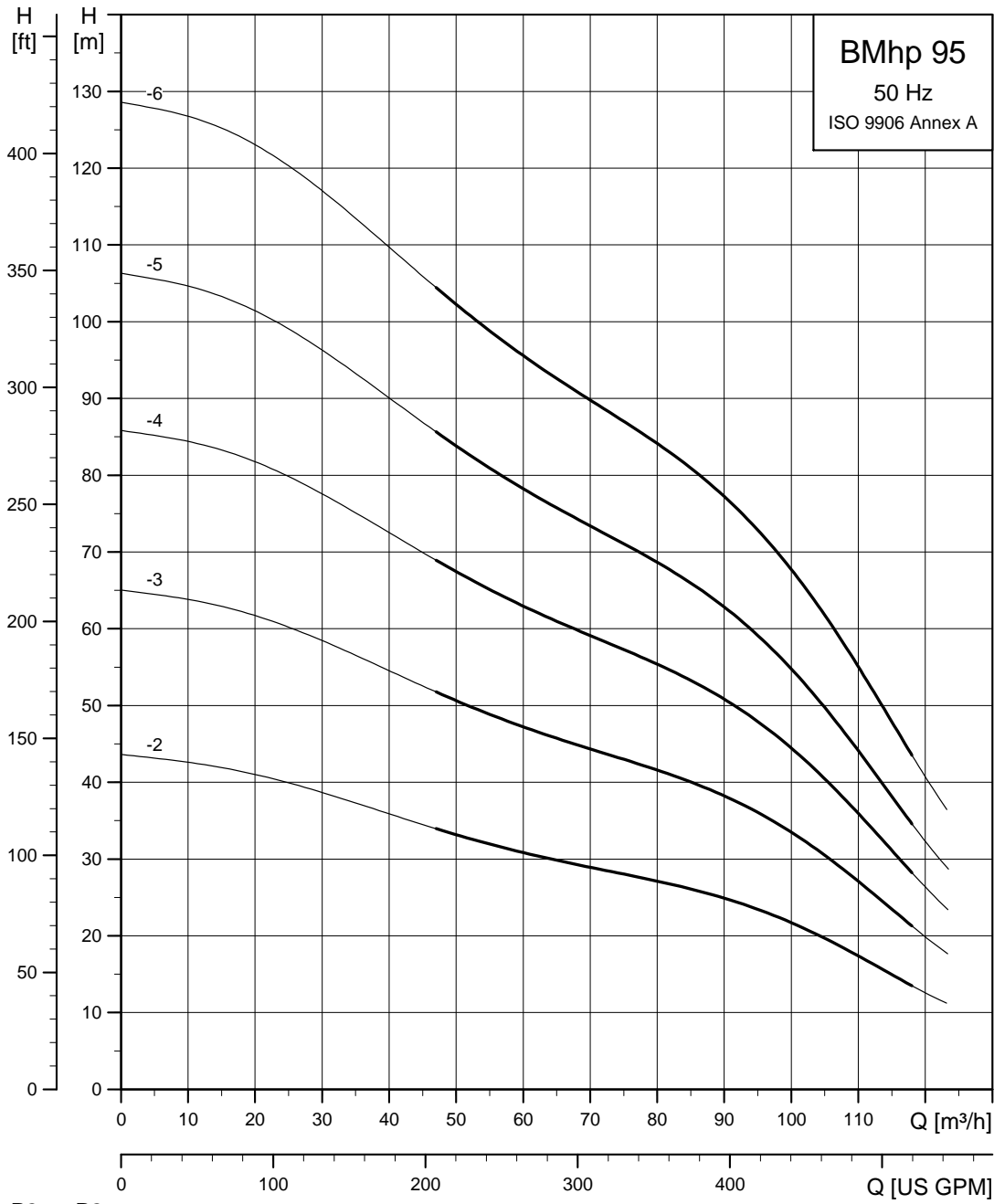

TM04 7960 3712

BMhp 125

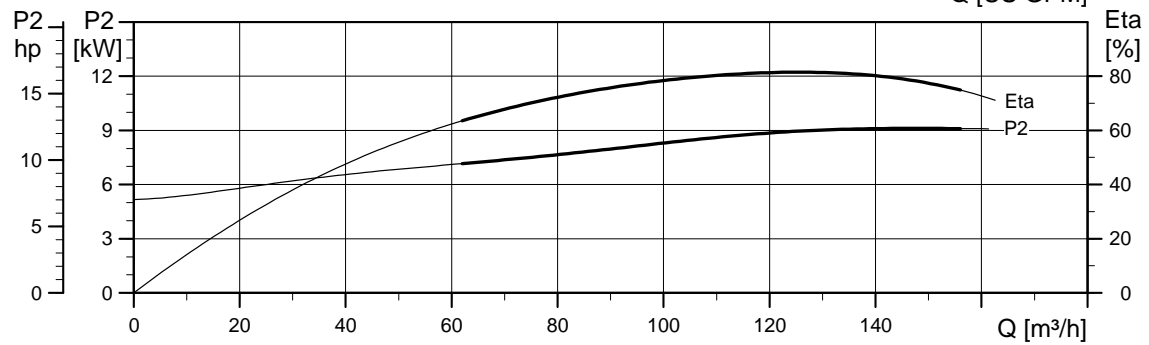
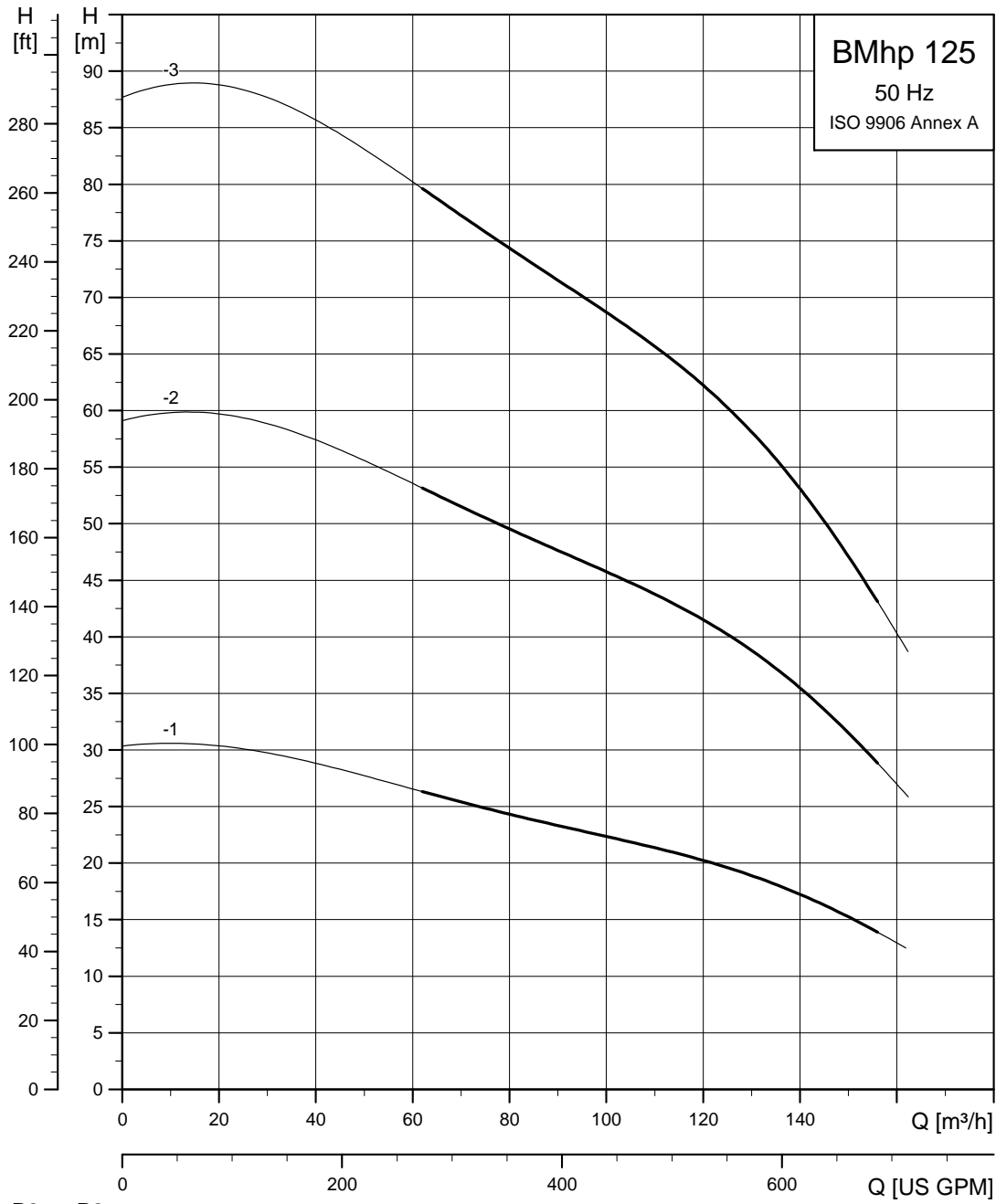

TM04 7961 3712

BMhp 160

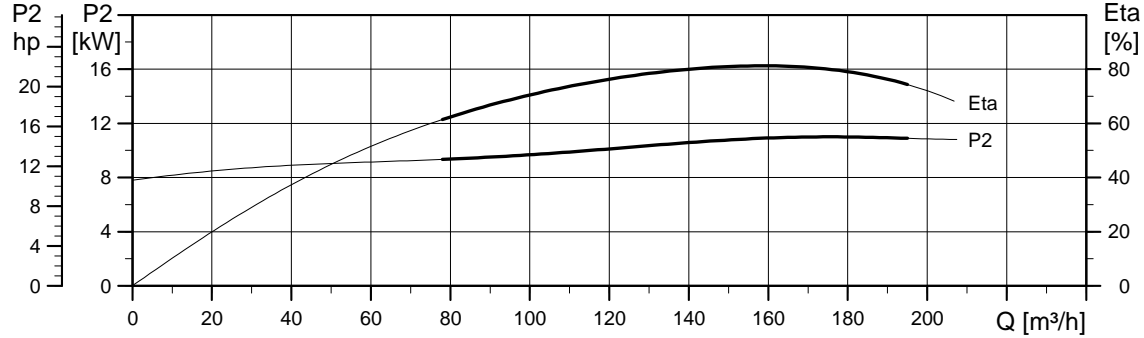
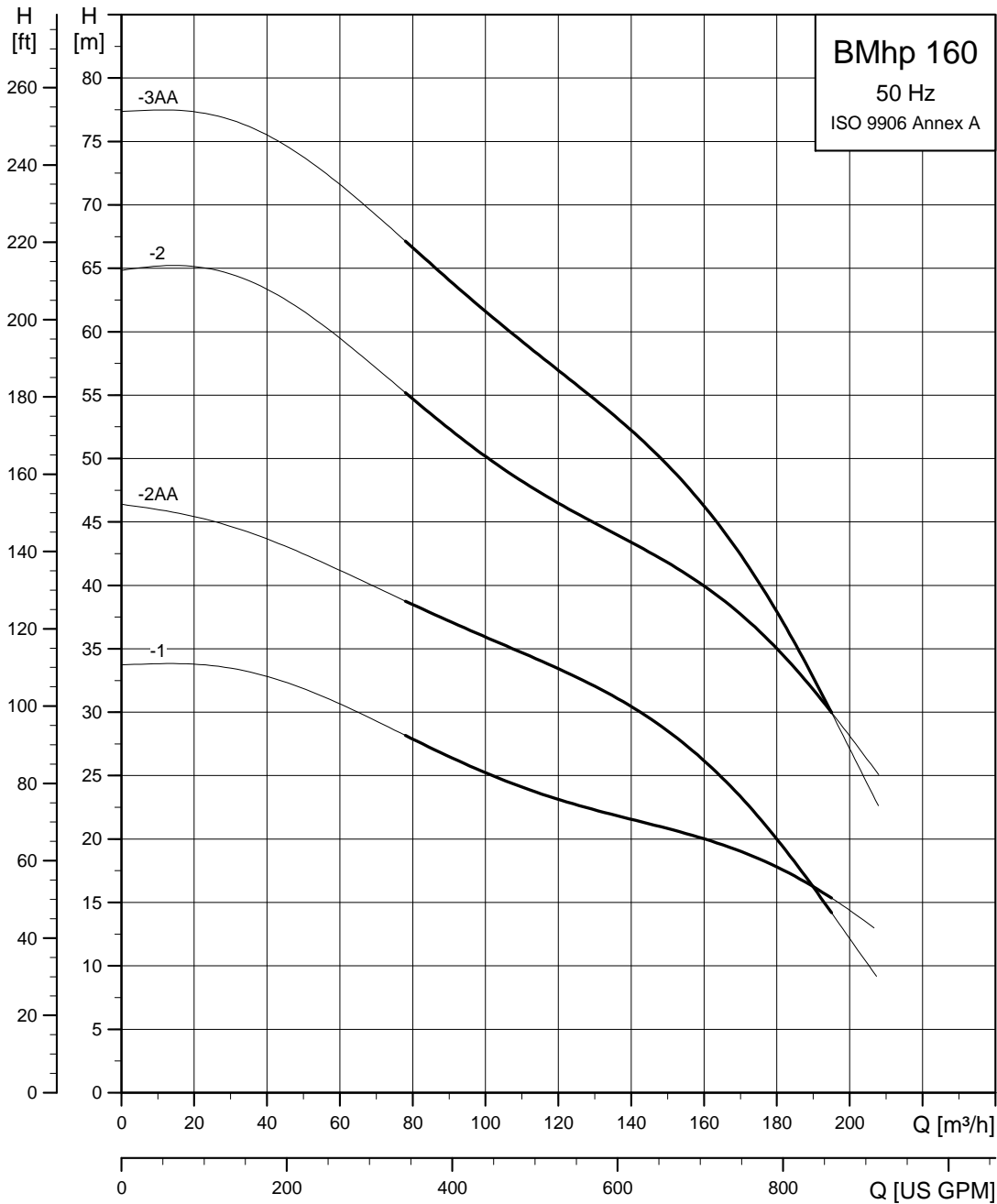

TM04 7962 3712

BMhp 215

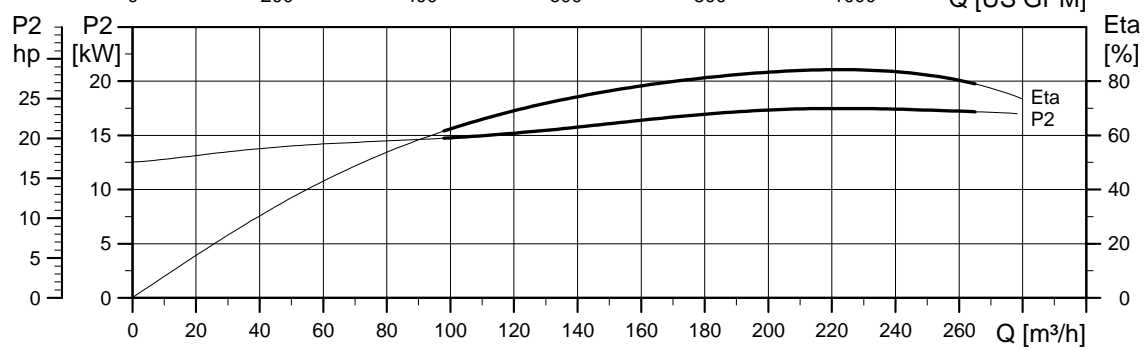
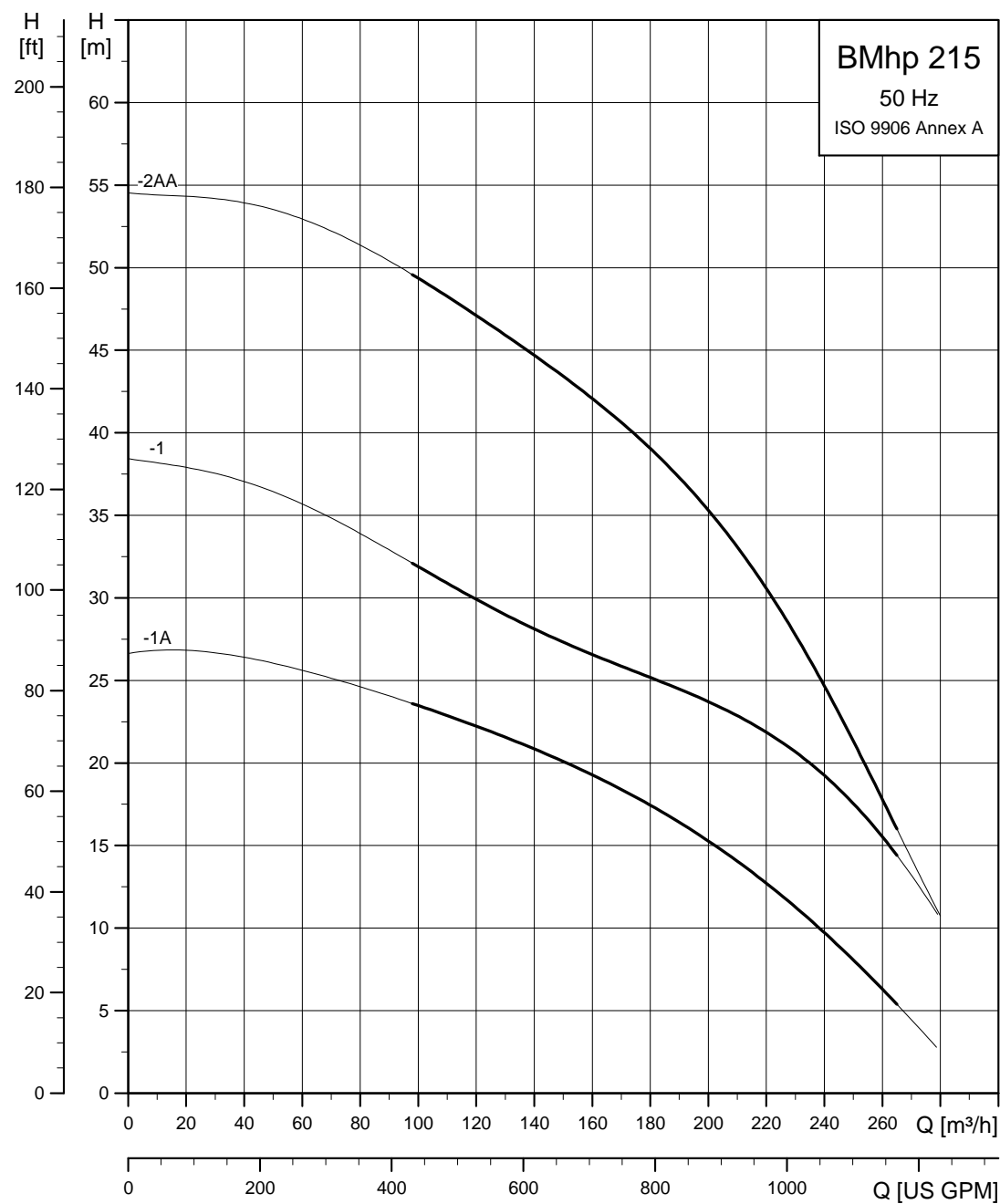

TM04 7963 3712

10. Order data, 50 Hz

BMhp 6" (with straight pipe)

Type	Motor output [P2]		Rated current I_N [A]	Length [L]		Product number R version	Weight [kg]		Ship. vol. [m ³]
	[kW]	[hp]		[mm]	[in]		Net	Gross	
BMhp 17-3	5.5	7.5	13.6 - 13.8	2100	82.7	95908982	73.0	104.5	0.399
BMhp 17-4	5.5	7.5	13.6 - 13.8	2100	82.7	96293261	74.5	106.0	0.399
BMhp 17-5	5.5	7.5	13.6 - 13.8	2100	82.7	96293262	76.0	107.5	0.399
BMhp 17-6	5.5	7.5	13.6 - 13.8	2100	82.7	96293263	77.3	109.0	0.399
BMhp 17-7	5.5	7.5	13.6 - 13.8	2100	82.7	96293264	79.0	110.5	0.399
BMhp 30-3	5.5	7.5	13.6 - 13.8	2100	82.7	95908983	75.5	107.0	0.399
BMhp 30-4	5.5	7.5	13.6 - 13.8	2100	82.7	96293265	77.5	109.0	0.399
BMhp 30-5	5.5	7.5	13.6 - 13.8	2100	82.7	96293266	79.5	111.0	0.399
BMhp 30-6	5.5	7.5	13.6 - 13.8	2100	82.7	96293267	81.5	113.0	0.399
BMhp 30-7	7.5	10.0	17.6 - 17.8	2100	82.7	96293268	85.5	117.0	0.399
BMhp 46-4	7.5	10.0	17.6 - 17.8	2100	82.7	96293269	86.0	117.5	0.399
BMhp 46-5	7.5	10.0	17.6 - 17.8	2100	82.7	96293270	88.0	119.5	0.399
BMhp 46-6	9.2	12.5	21.8 - 21.8	2700	106.3	96293271	100.5	160.0	0.500
BMhp 46-7	11.0	15.0	24.8 - 25.5	2700	106.3	96293272	105.5	165.0	0.500
BMhp 60-3	5.5	7.5	13.6 - 13.8	2100	82.7	95908984	80.5	112.0	0.399
BMhp 60-4	7.5	10.0	17.6 - 17.8	2100	82.7	96293273	86.0	117.5	0.399
BMhp 60-5	9.2	12.5	21.8 - 21.8	2100	82.7	96293274	93.5	125.0	0.399
BMhp 60-6	11.0	15.0	24.8 - 25.5	2700	106.3	96293275	104.0	163.5	0.500
BMhp 60-7	13.0	17.5	30.0 - 30.5	2700	106.3	96293276	109.0	168.5	0.500

On request, the BMhp is available in other voltages and with all stages indicated in the standard SP pump range.

Dimensional sketch

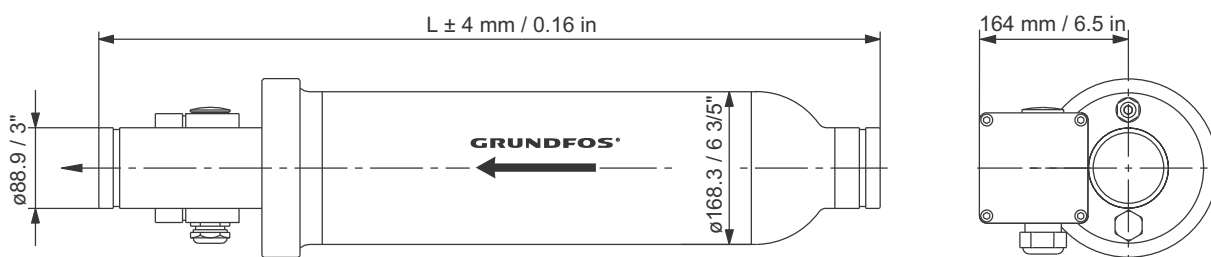

TM00 3799 4312

One set of connecting fittings is required for each system. See section 13. *Accessories*, page 71.

BMhp 8" (with straight pipe)

Type	Motor output [P2]		Rated current I_N [A]	Length [L]		Product number R version	Weight [kg]		Ship. vol. [m ³]
	[kW]	[hp]		[mm]	[in]		Net	Gross	
BMhp 77-2	7.5	10.0	17.6 - 17.8	2400	94.5	95908985	133.0	186.0	0.919
BMhp 77-3	11.0	15.0	24.8 - 25.5	2400	94.5	96293289	145.0	198.0	0.919
BMhp 77-4	15.0	20.0	34.0 - 34.5	2400	94.5	96293290	155.5	208.5	0.919
BMhp 77-5	18.5	25.0	42.0 - 42.5	2750	108.3	96293291	171.5	232.0	1.041
BMhp 77-6	22.0	30.0	47.5 - 50.0	2750	108.3	96293292	181.0	241.5	1.041
BMhp 95-2	9.2	12.5	21.8 - 21.8	2100	82.7	95908986	132.5	179.0	0.815
BMhp 95-3	13.0	17.5	30.0 - 30.5	2400	94.5	96293293	148.0	201.0	0.919
BMhp 95-4	18.5	25.0	42.0 - 42.5	2400	94.5	96293294	161.0	214.0	0.919
BMhp 95-5	22.0	30.0	47.5 - 50.0	2750	108.3	96293295	177.5	238.0	1.041
BMhp 95-6	26.0	35.0	57.0 - 59.0	2750	108.3	96293296	186.5	247.0	1.041
BMhp 125-1	11.0	15.0	24.8 - 25.5	2100	82.7	96293297	142.0	188.0	0.815
BMhp 125-2	22.0	30.0	47.5 - 50.0	2400	94.5	96293298	172.5	225.5	0.919
BMhp 125-3	30.0	40.0	66.5 - 68.5	2400	94.5	96293299	192.0	245.0	0.919
BMhp 160-1	13.0	17.5	30.0 - 30.5	2100	82.7	96293300	145.0	191.0	0.815
BMhp 160-2AA	18.5	25.0	42.0 - 42.5	2400	94.5	95908987	166.0	219.0	0.919
BMhp 160-2	26.0	35.0	57.0 - 59.0	2400	94.5	96293301	178.0	231.0	0.919
BMhp 160-3AA	30.0	40.0	66.5 - 68.5	2400	94.5	96293302	192.0	245.0	0.919
BMhp 215-1A	15.0	20.0	34.0 - 34.5	2400	94.5	96902422	161.0	214.0	0.919
BMhp 215-1	18.5	25.0	42.0 - 42.5	2400	94.5	96293315	166.0	219.0	0.919
BMhp 215-2AA	30.0	40.0	66.5 - 68.5	2400	94.5	96293316	196.0	249.0	0.919

On request, the BMhp is available in other voltages and with all stages indicated in the standard SP pump range.

Connections

Size	Type	Victaulic coupling
BMhp 8"	BMhp 77 - BMhp 95	5" / Ø139, style 489
BMhp 8"	BMhp 125 - BMhp 215	6" / Ø168, style 77S

Dimensional sketch

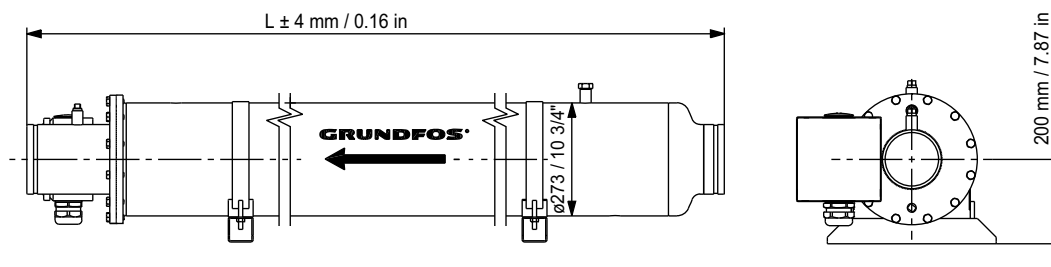

One set of connecting fittings is required for each system. See section 13. Accessories, page 71.

TM01 1424 3812

11. Performance curves, 60 Hz

BMhp 17

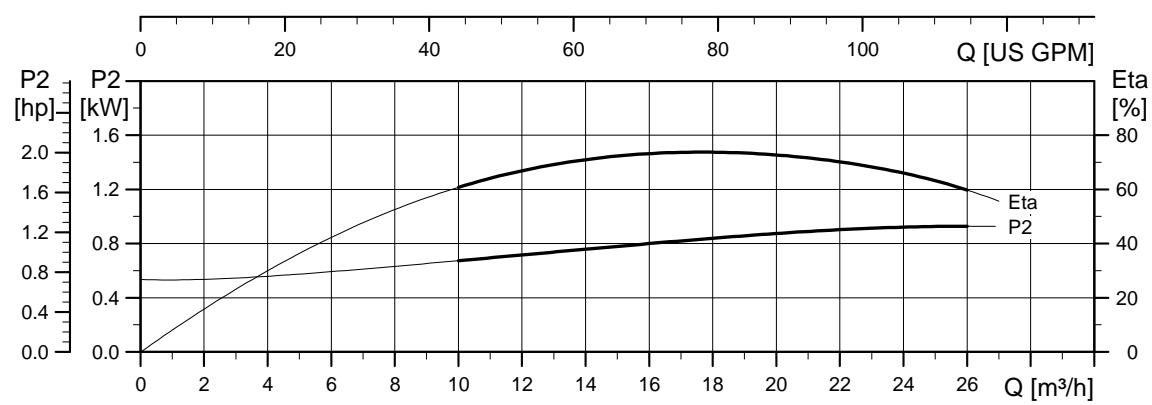
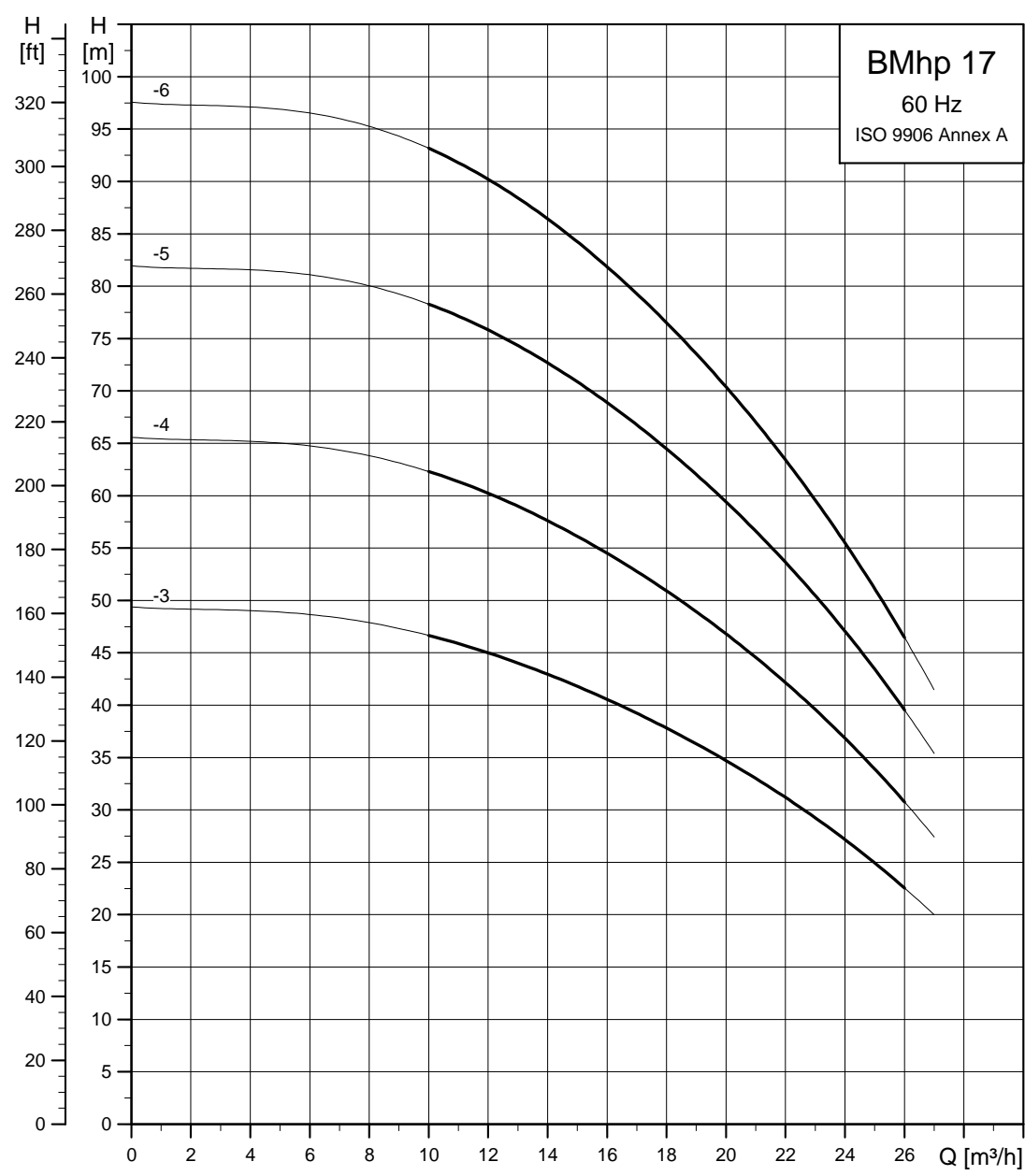

TM04 7964 3712

BMhp 30

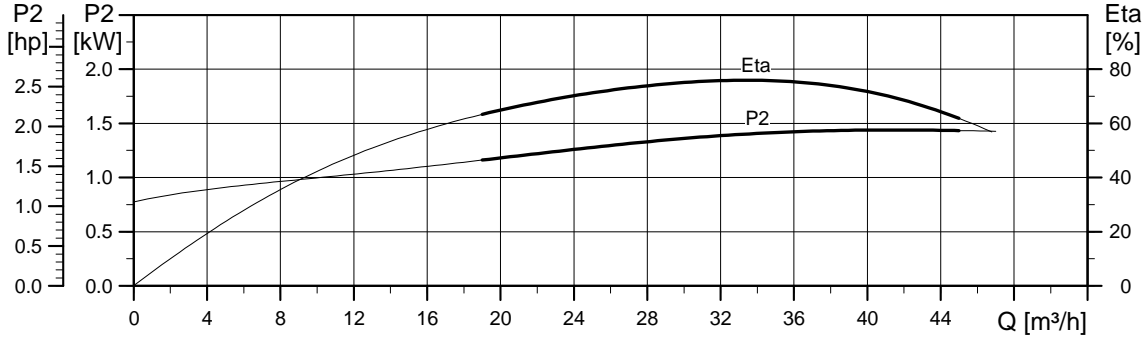
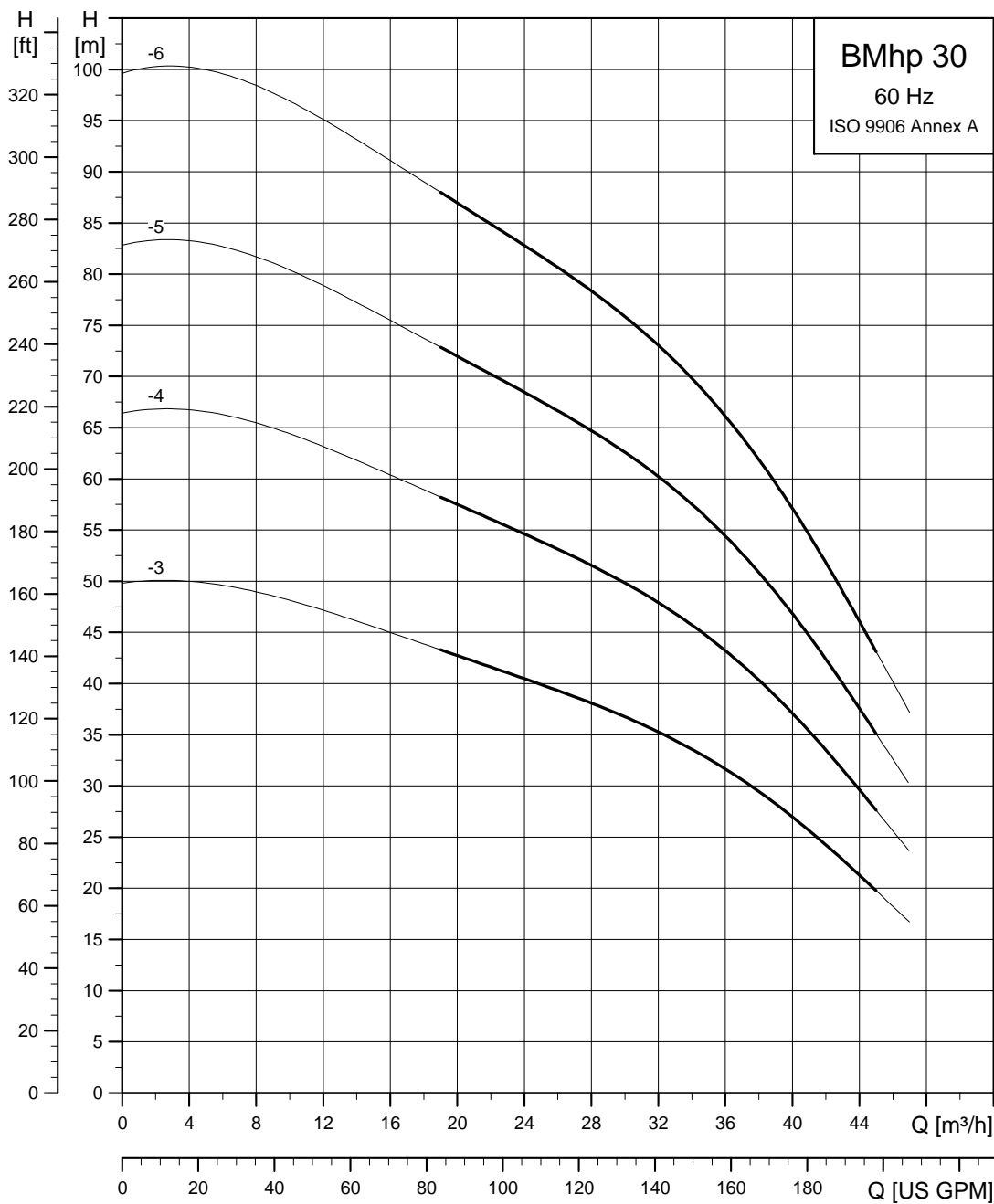

TM04 7965 3712

BMhp 46

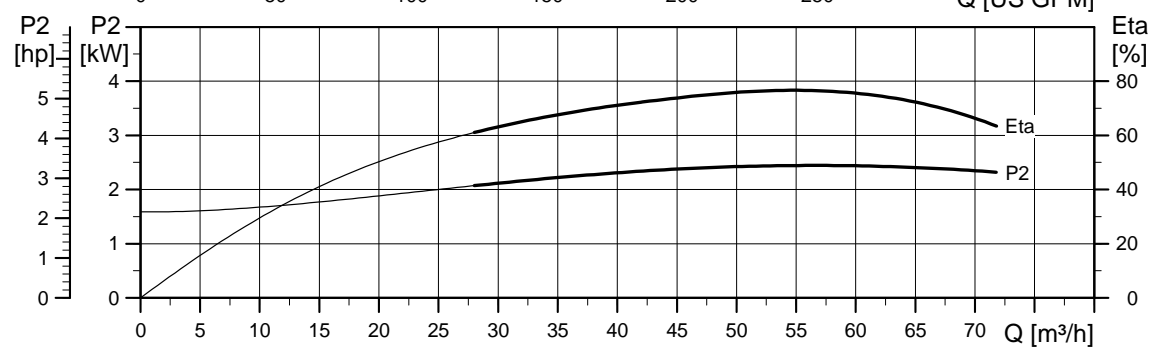
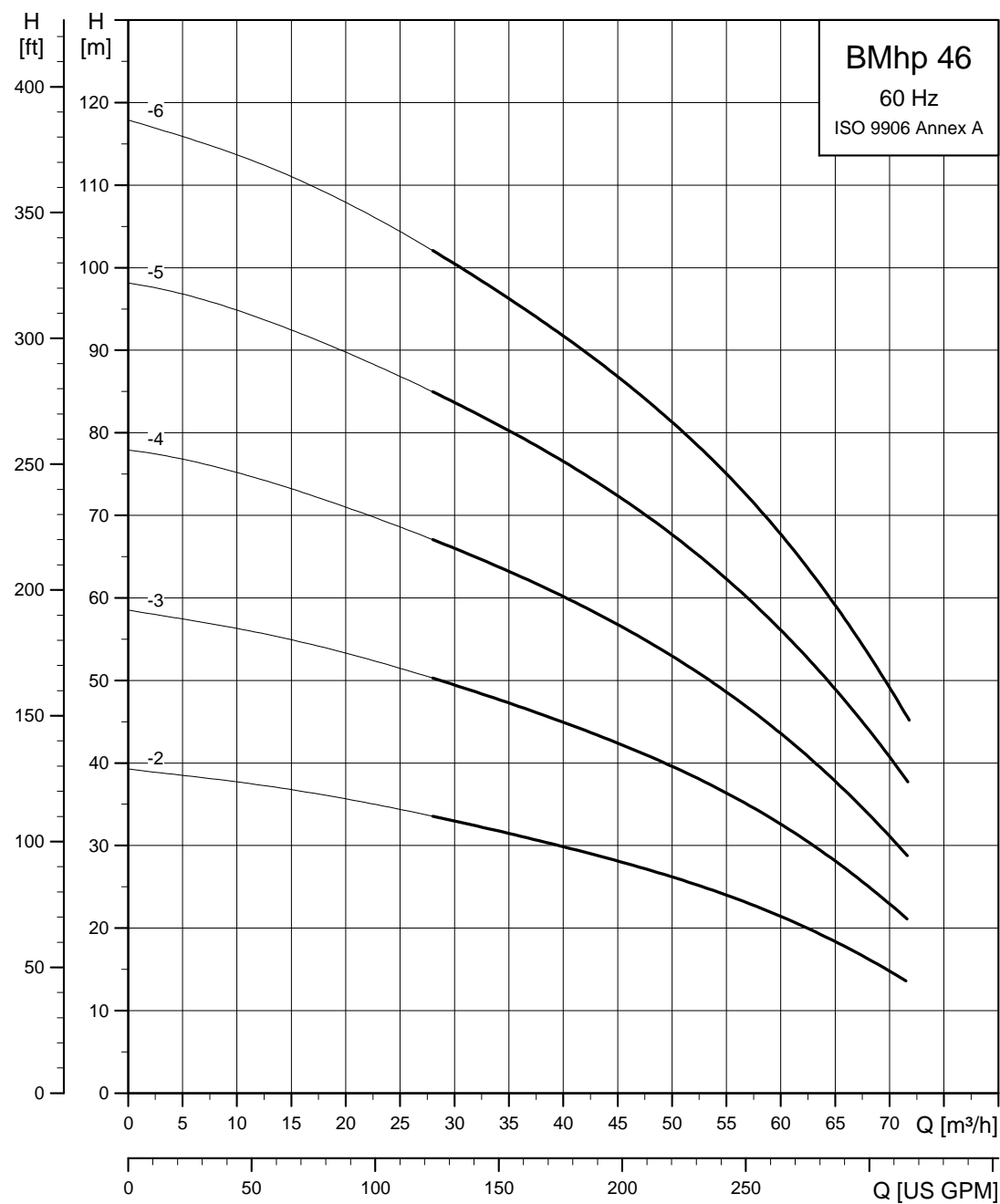

TM04 7966 2510

BMhp 60

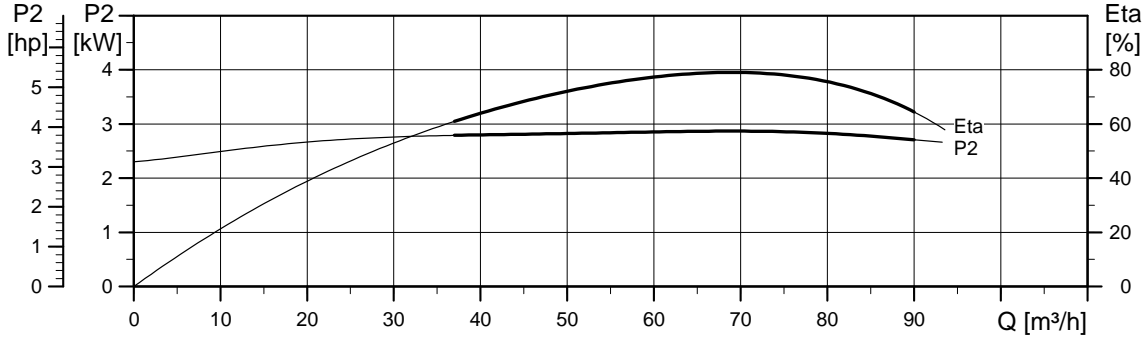
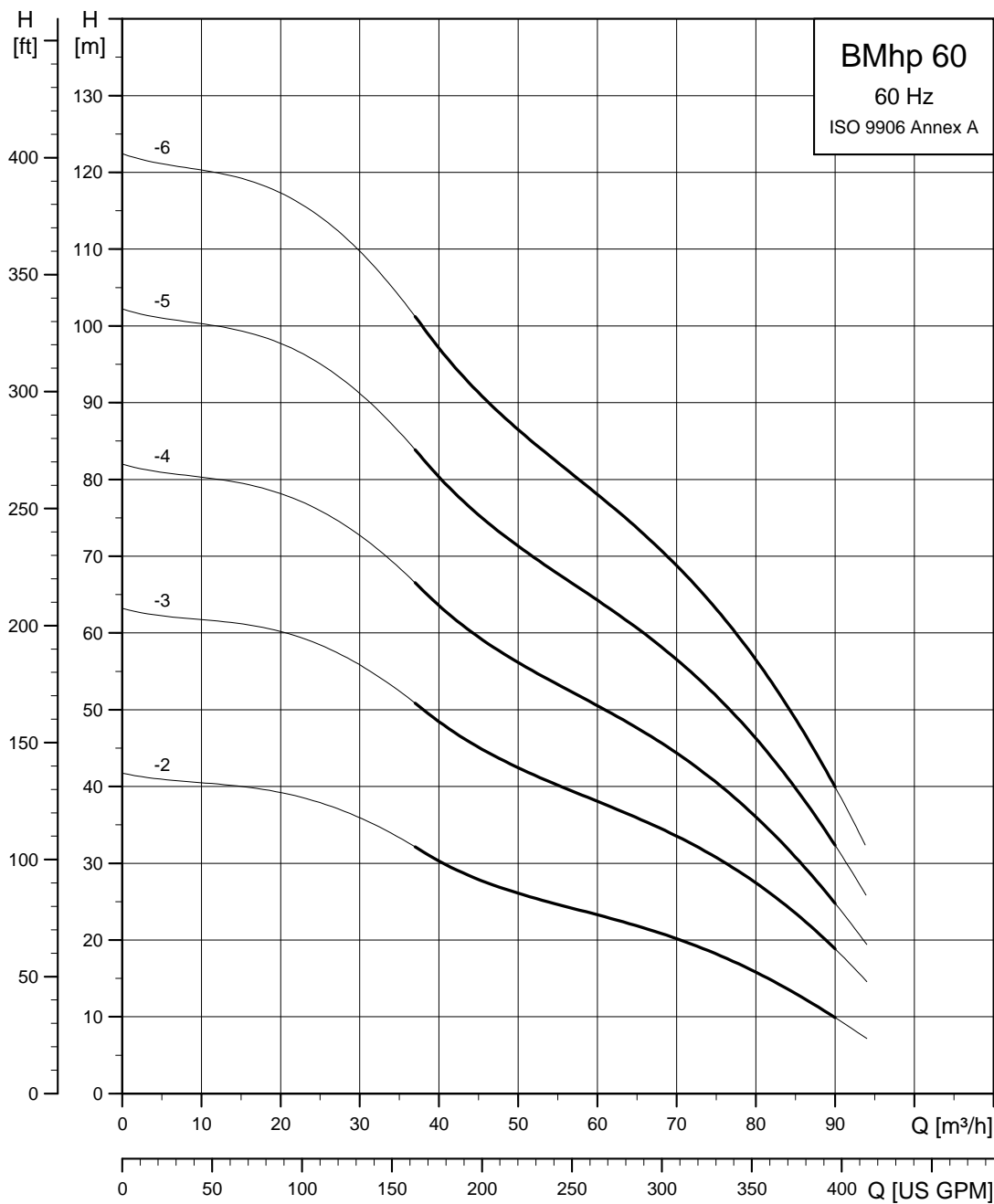

TM04 7967 2510

BMhp 77

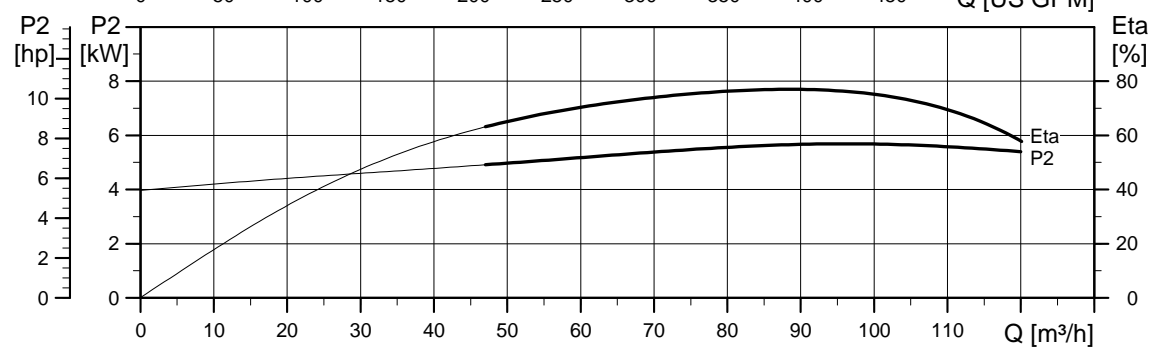
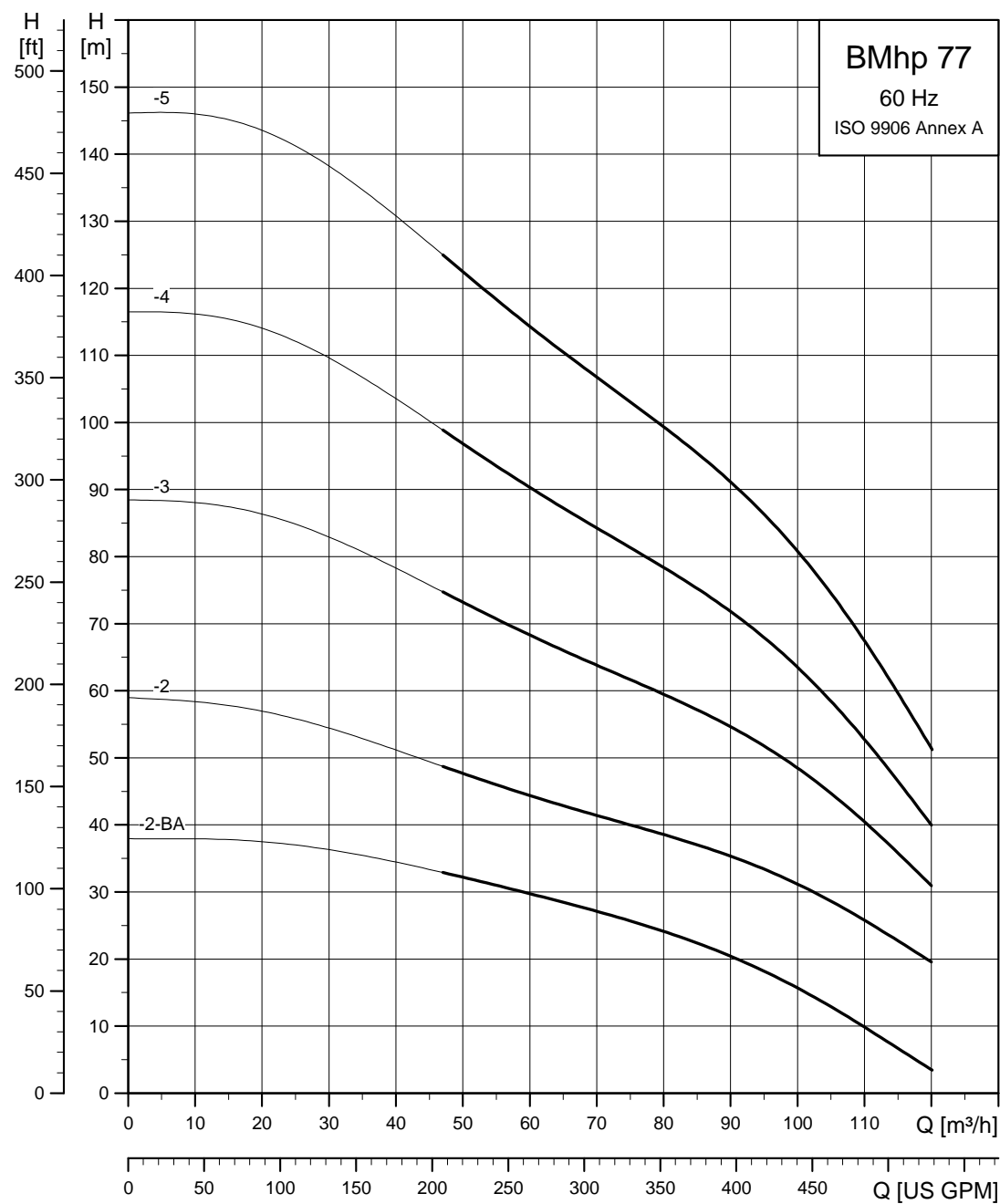

TM04 7968 2510

BMhp 95

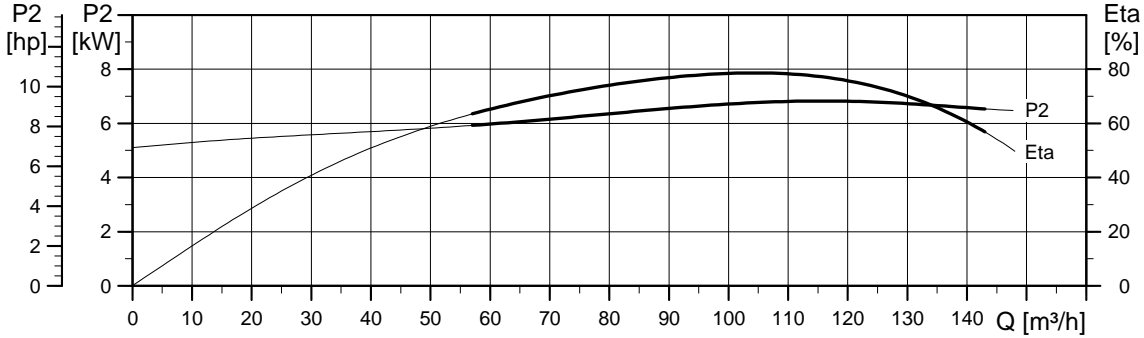
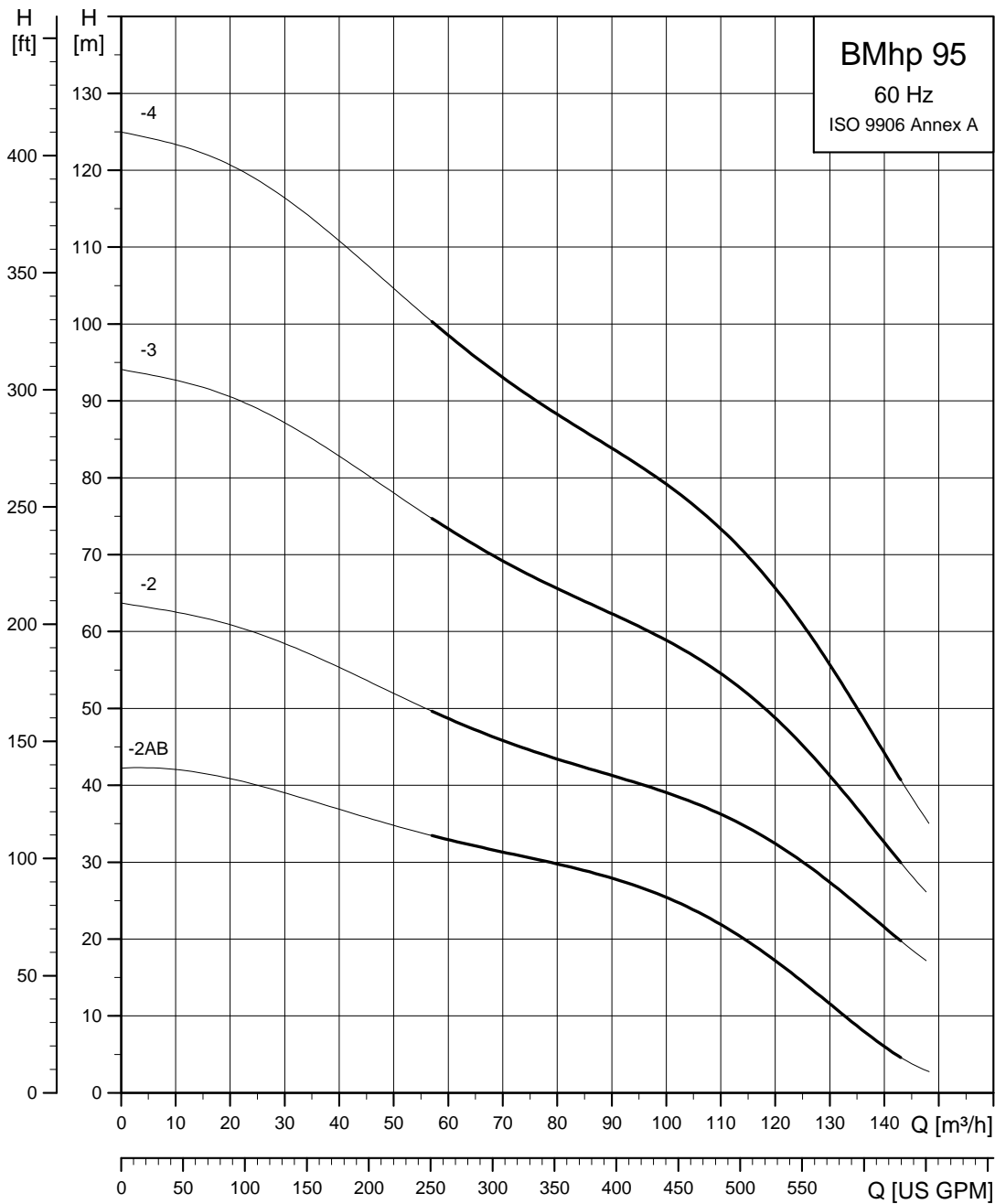

TM04 7969 3712

BMhp 125

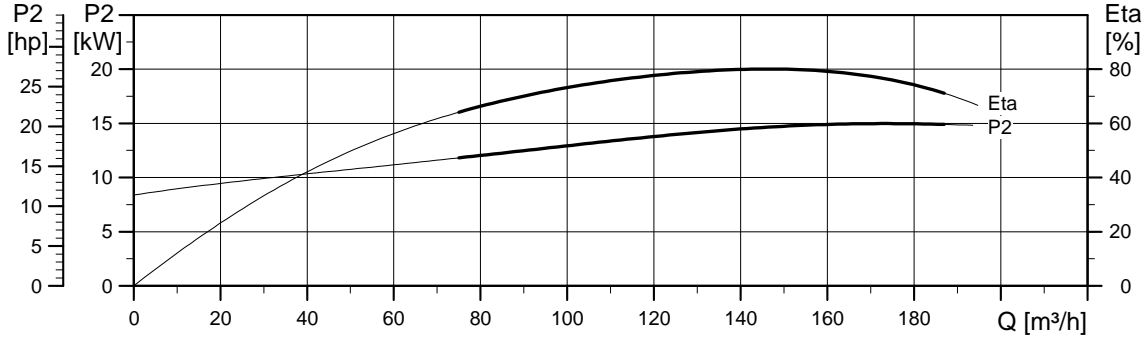
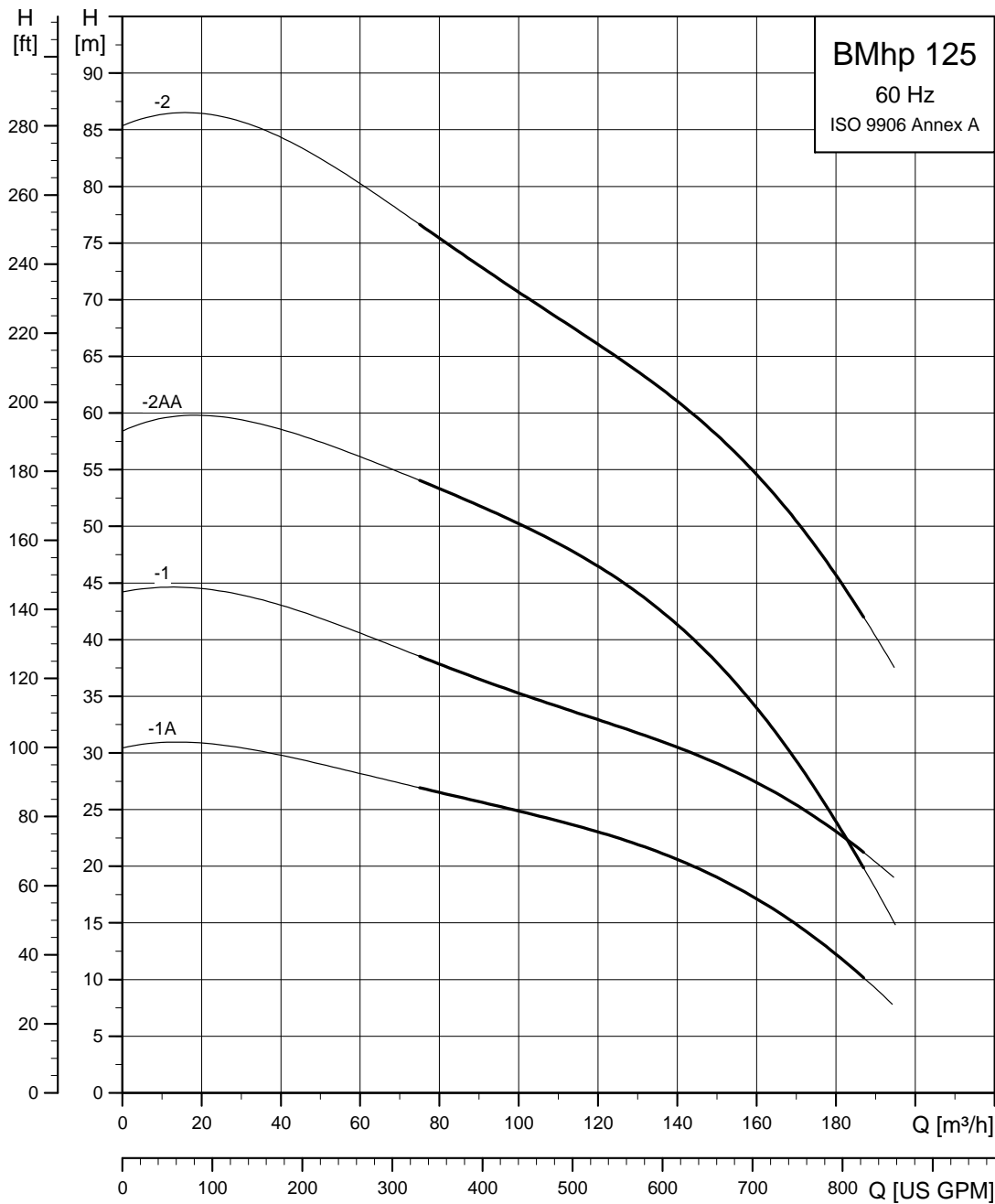

TM04 7970 3712

BMhp 160

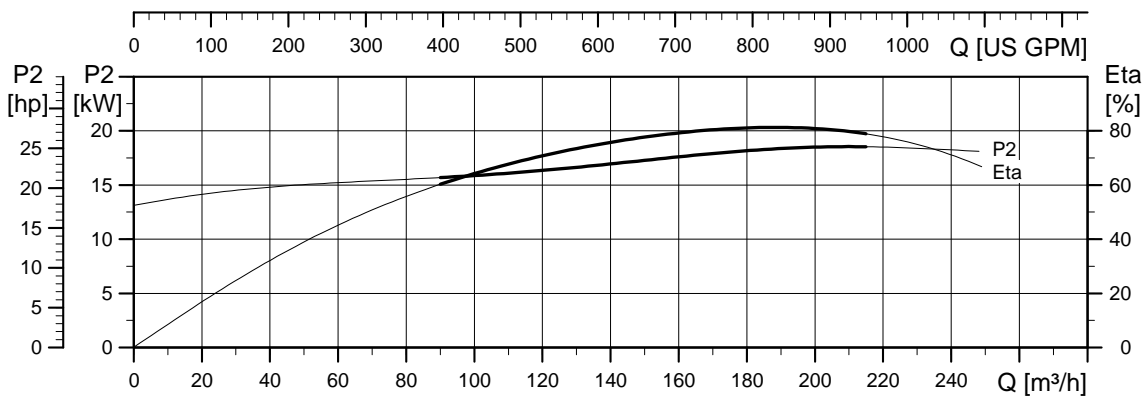
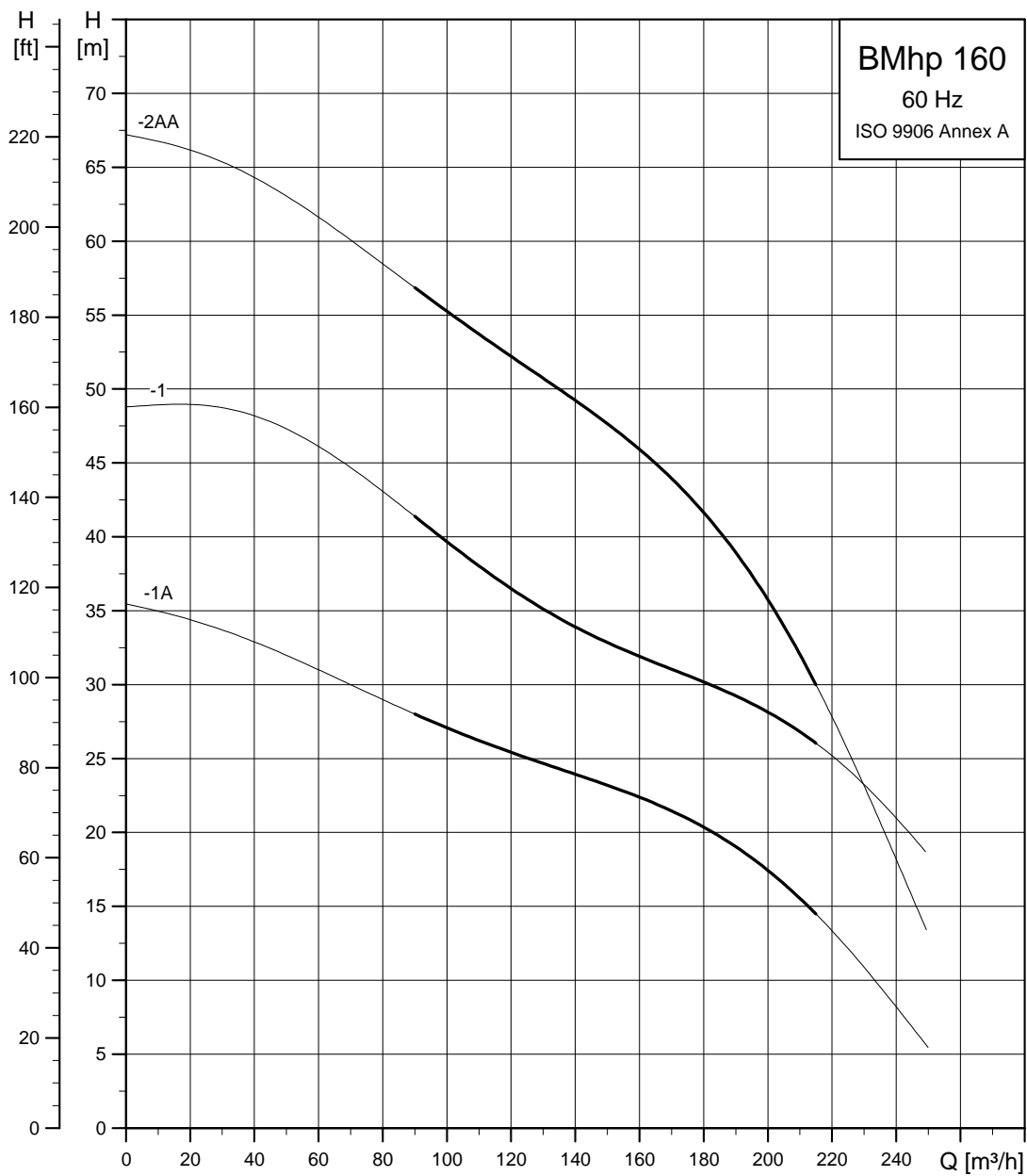

TM04 7971 3712

BMhp 215

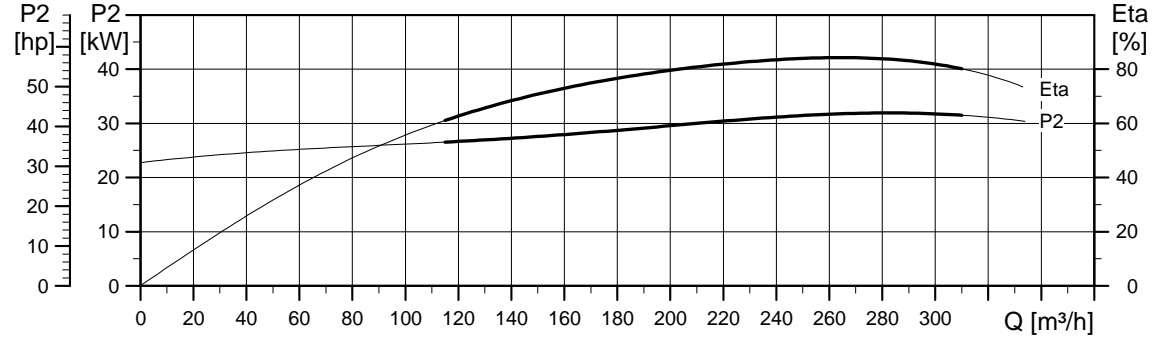
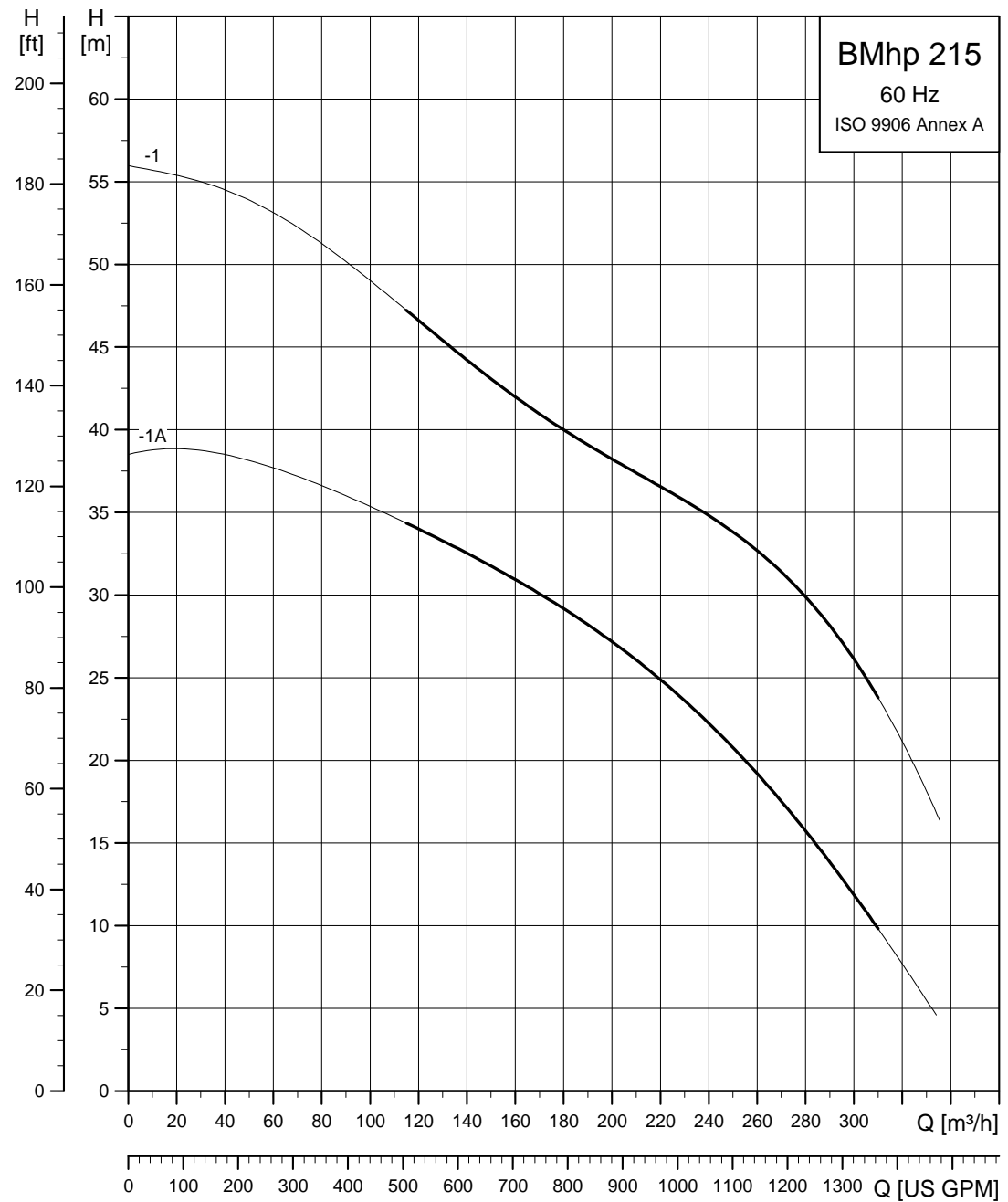

TM04 7972 3712

12. Order data, 60 Hz

BMhp 6" (with straight pipe)

Type	Motor output [P2]		Rated current	Length [L]		Product number	Weight [kg]		Ship. vol. [m ³]
	[kW]	[hp]	I _N [A]	[mm]	[in]		Net	Gross	
BMhp 17-3	5.5	7.5	13.2 - 13.2	2100	82.7	95908989	73.0	104.5	0.399
BMhp 17-4	5.5	7.5	13.2 - 13.2	2100	82.7	96293277	74.5	106.0	0.399
BMhp 17-5	5.5	7.5	13.2 - 13.2	2100	82.7	96293278	76.0	107.5	0.399
BMhp 17-6	5.5	7.5	13.2 - 13.2	2100	82.7	96293279	77.5	109.0	0.399
BMhp 30-3	5.5	7.5	13.2 - 13.2	2100	82.7	95908990	75.5	107.0	0.399
BMhp 30-4	5.5	7.5	13.2 - 13.2	2100	82.7	96293280	77.5	109.0	0.399
BMhp 30-5	7.5	10.0	17.0 - 17.4	2100	82.7	96293281	83.0	114.5	0.399
BMhp 30-6	9.2	12.5	21.0 - 21.8	2100	82.7	96768215	90.5	122.0	0.399
BMhp 46-2	5.5	7.5	13.2 - 13.2	2100	82.7	95908991	78.5	110.0	0.399
BMhp 46-3	7.5	10.0	17.0 - 17.4	2100	82.7	95908992	84.0	115.5	0.399
BMhp 46-4	9.2	12.5	21.0 - 21.8	2100	82.7	96293283	91.5	123.0	0.399
BMhp 46-5	13.0	17.5	28.5 - 29.5	2100	82.7	96293284	99.5	131.0	0.399
BMhp 46-6	15.0	20.0	32.5 - 33.5	2700	106.3	96293285	110.5	170.0	0.500
BMhp 60-2	5.5	7.5	13.2 - 13.2	2100	82.7	95908993	78.5	110.0	0.399
BMhp 60-3	9.2	12.5	21.0 - 21.8	2100	82.7	95908994	89.5	121.0	0.399
BMhp 60-4	11.0	15.0	24.0 - 25.5	2100	82.7	96293286	94.5	126.0	0.399
BMhp 60-5	15.0	20.0	32.5 - 33.5	2100	82.7	96293287	103.5	135.0	0.399
BMhp 60-6	18.5	25.0	41.0 - 42.0	2700	106.3	96293288	116.0	175.5	0.500

On request, the BMhp is available in other voltages and with all stages indicated in the standard SP pump range.

Dimensional sketch

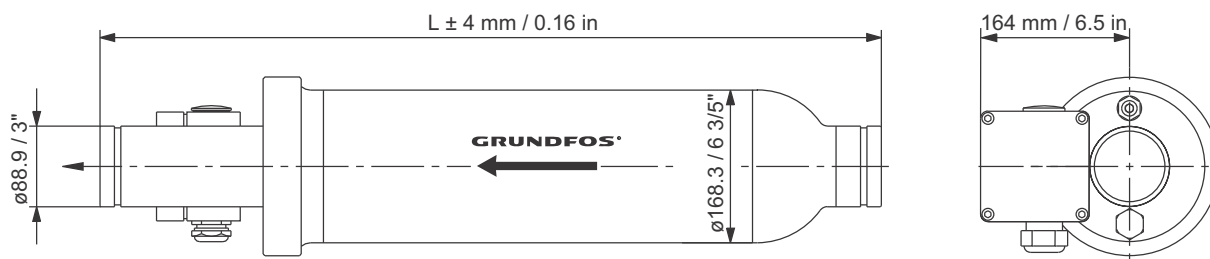

TM00 3799 4312

One set of connecting fittings is required for each system. See section 13. Accessories, page 71.

BMhp 8" (with straight pipe)

Type	Motor output [P2]		Rated current I_N [A]	Length [L]		Product number R version	Weight [kg]		Ship. vol. [m ³]
	[kW]	[hp]		[mm]	[in]		Net	Gross	
BMhp 77-2A	7.5	10.0	17.0 - 17.4	2400	94.5	95908995	132.0	185.0	0.919
BMhp 77-2	11.0	15.0	24.0 - 25.5	2400	94.5	96293303	142.0	194.5	0.919
BMhp 77-3	18.5	25.0	41.0 - 42.0	2400	94.5	96293304	158.0	210.5	0.919
BMhp 77-4	22.0	30.0	46.5 - 48.0	2400	94.5	96293305	167.0	220.0	0.919
BMhp 77-5	30.0	40.0	63.0 - 66.5	2750	108.3	96293306	191.0	251.5	1.041
BMhp 95-2AB	9.2	12.5	21.0 - 21.8	2100	82.7	95908996	135.0	175.0	0.815
BMhp 95-2	13.0	17.5	28.5 - 29.5	2100	82.7	96293307	145.0	185.0	0.815
BMhp 95-3	22.0	30.0	46.5 - 48.0	2400	94.5	96293308	164.0	216.5	0.919
BMhp 95-4	30.0	40.0	63.0 - 66.5	2400	94.5	96293309	181.0	233.5	0.919
BMhp 125-1A	11.0	15.0	24.0 - 25.5	2100	82.7	95908997	142.0	188.0	0.815
BMhp 125-1	18.5	25.0	41.0 - 42.0	2400	94.5	96293310	161.0	213.5	0.919
BMhp 125-2AA	22.0	30.0	46.5 - 48.0	2400	94.5	95908998	173.0	225.5	0.919
BMhp 125-2	30.0	40.0	63.0 - 66.5	2400	94.5	96293311	186.0	239.0	0.919
BMhp 160-1A	15.0	20.0	32.5 - 33.5	2100	82.7	95908999	155.0	195.0	0.815
BMhp 160-1	22.0	30.0	46.5 - 48.0	2400	94.5	96293312	167.0	219.5	0.919
BMhp 160-2AA	26.0	35.0	54.5 - 57.5	2400	94.5	96293313	178.0	230.5	0.919
BMhp 215-1A	22.0	30.0	46.5 - 48.0	2400	94.5	95909000	173.0	226.0	0.919
BMhp 215-1	30.0	40.0	63.0 - 66.5	2400	94.5	96293314	186.0	239.0	0.919

On request, the BMhp is available in other voltages and with all stages indicated in the standard SP pump range.

* Full-load current I_{SF} applies to 3 x 460 V.

Connections

Size	Type	Victaulic coupling
BMhp 8"	BMhp 77 - BMhp 95	5" / Ø139, style 489
BMhp 8"	BMhp 125 - BMhp 215	6" / Ø168, style 77S

Dimensional sketch

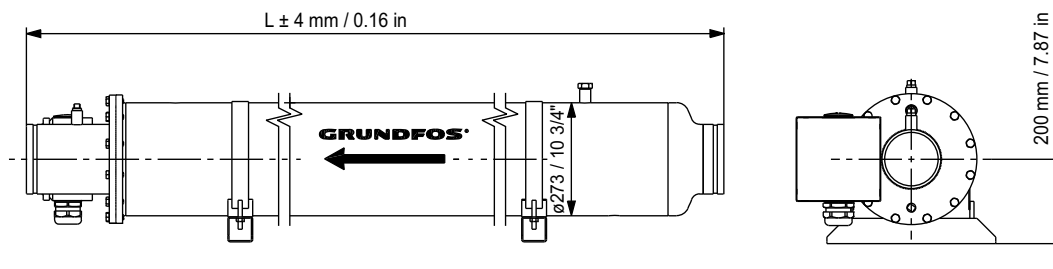

One set of connecting fittings is required for each system. See section 13. *Accessories*, page 71.

TM01 1424 3812

13. Accessories

CUE frequency converter

The Grundfos CUE is a series of external frequency converters designed for speed control of a wide range of Grundfos pumps.

When a CUE is installed, the motor requires no further motor protection.

The CUE offers quick and easy set-up and commissioning compared to a standard frequency converter because of the start-up guide. Simply key in application-specific variables such as motor data, pump family, control function (e.g. constant pressure), sensor type, and setpoint, and the CUE will automatically set all necessary parameters.

The CUE enables gentle pumping and thereby protects the water reservoir and the rest of the distribution system, as water hammer can be avoided by adjusting ramp times up and down.

Overview of the CUE range

Supply voltage [V]	Power range [kW]						
	0.55	0.75	1.1	7.5	11	45	250
3 x 525-690							
3 x 525-600							
3 x 380-500							
3 x 200-240							
1 x 200-240							

The CUE is available in two enclosure classes:

- IP20/21
- IP54/55.

RFI filters

To meet the EMC requirements, the CUE comes with the following types of built-in radio frequency interference filter (RFI).

Voltage [V]	Typical shaft power, P2 [kW]	RFI filter type	Application
1 x 200-240	1.1 - 7.5	C1	Domestic
3 x 200-240	0.75 - 45	C1	
3 x 380-500	0.55 - 90	C1	Domestic/industry
	110-250	C2	
3 x 525-600	0.75 - 7.5	C3	Industry
3 x 525-690	11-25	C3	



GrA4404

Fig. 11 The CUE range

Functions

The CUE has a wide range of pump-specific functions, such as

- constant pressure
- constant level
- constant flow rate
- constant temperature
- constant curve.

CUE features

- Startup guide
The CUE incorporates an innovative start-up guide for the general setting of the CUE including the setting of the correct direction of rotation. The start-up guide is started the first time when the CUE is connected to the power supply.
- Check of direction of rotation.
- Duty/standby operation.
- Dry-running protection.
- Low-flow stop function.

Inputs and outputs

The CUE incorporates various inputs and outputs:

- 1 RS-485 GENIbus connection
- 1 analog input, 0-10 V, 0/4-20 mA
 - external setpoint
- 1 analog input, 0/4-20 mA
 - sensor input, feedback sensor
- 1 analog output, 0-20 mA
- 4 digital inputs
 - start/stop and three programmable inputs
- 2 signal relays (C/NO/NC)
 - programmable.

Accessories for the CUE

Grundfos offers various accessories for the CUE.

MCB 114 sensor input module

The MCB 114 offers additional analog inputs for the CUE:

- 1 analog input, 0/4-20 mA
- 2 inputs for Pt100 and Pt1000 temperature sensors.

Output filters

Output filters are used primarily to protect the motor against overvoltage and increased operating temperature. However, output filters can also be used to reduce acoustic noise from the motor.

Grundfos offers two types of output filter as accessories for the CUE:

- dU/dt filters
- sine-wave filters.

Floor-mounting option

The CUE is as standard installed on the wall.

The enclosures D1 and D2 can also be installed on the floor on a pedestal designed for that purpose.

For information about enclosures, see the product-specific documentation for the CUE.

IP21/NEMA1 option

An IP20 enclosure can be upgraded to IP21/NEMA1 by using the IP21/NEMA1 option. The power terminals (mains and motor) will be covered.

Sensors

The following sensors can be used in connection with the CUE. All sensors are with 4-20 mA output signal.

- pressure sensors, up to 25 bar
- temperature sensors
- differential-pressure sensors
- differential-temperature sensors
- flowmeters
- potentiometer box for external setpoint setting.

Gateways

The CUE has a standard RS-485 GENIbus interface. Gateways to convert to other bus standards are available as accessories.

The CIU family (CIU = Communication Interface Units) can convert from GENIbus to the most common fieldbuses in the world:

- CIU 100 converts from GENIbus to LonWorks
- CIU 150 converts from GENIbus to Profibus DP
- CIU 200 converts from GENIbus to Modbus RTU
- CIU 250 is a GSM modem which can send SMS messages in case of alarms, etc.

Control MPC

Control MPC, a multi-pump control system for the control of parallel-connected CUE pump solutions.

Use of output filters

The table below shows in which cases an output filter is required. From the table, it can be seen if a filter is required, and which type to use.

The selection depends on these factors:

- pump type
- motor cable length
- the required reduction of acoustic noise from the motor.

Pump type	Typical shaft power P2	dU/dt filter	Sine-wave filter
SP with 380 V motor and up	Up to 7.5 kW 11 kW and up	- 0-150 m	0-300 m 150-300 m

The lengths stated apply to the motor cable.

Cables used in CUE installations

Note: When the CUE is installed in connection with SP pumps, we distinguish between two types of installation:

- installation in EMC-insensitive sites. See fig. 12.
- installation in EMC-sensitive sites. See fig. 13.

The two types of installation are different when it comes to the use of screened cable.

Note: Drop cables are always unscreened.

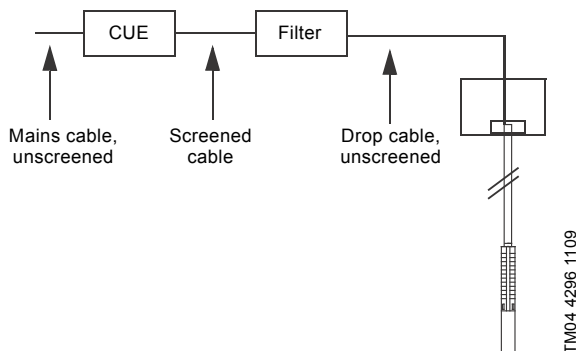

TM04 4296 1109

Fig. 12 Example of installation in EMC-insensitive sites

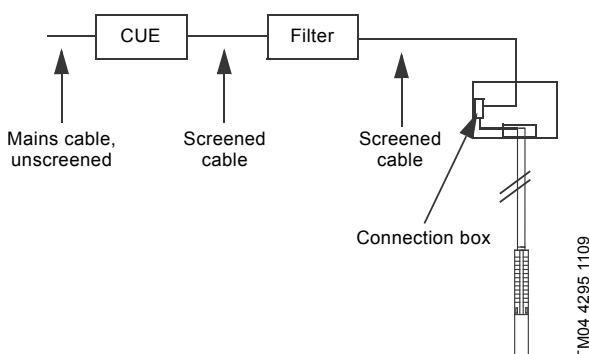

TM04 4295 1109

Fig. 13 Example of installation in EMC-sensitive sites

Screened cables are required in those parts of the installation where the surroundings must be protected against EMC.

The CUE is the right choice of frequency converter in SP installations as it meets all basic issues. The CUE has a pre-installed start-up guide which takes the installer through all the necessary settings.

The table below shows the different issues to be considered when using frequency converters in SP installations.

Issues to be considered	Explanation
Ramp (up and down): Maximum 3 seconds.	The journal bearings must be lubricated in order to limit wear and overheating of windings.
Use temperature monitoring by Pt sensor.	Overheating of the motor => low insulation resistance => sensitive to voltage peaks.
Reduce peak voltages (max. 800 V peaks).	Never exceed peak voltages of 850 V at motor leads.
For MS and MMS, we recommend to use motors with 10 % extra in given duty point. For MMS, always use motors (PE2-PA-wound).	Grundfos CUE with output filter is a safe solution.
Remember output filter.	Cables act as an amplifier => measure peaks at the motor.
Rise time (dU/dt) shall be limited to a maximum of 1000 V/μs. Determined by the equipment in the CUE.	Time between switches is an expression of losses, so in the future, we might have to exceed the limit of 1000 V/μs. The solution is not higher insulation of the motor, but filter in the output from the CUE.
Min. 30 Hz. Use a 60 Hz motor for larger range.	Too low speed => no lubrication of journal bearings.
Size the CUE in respect of the current, not the power output.	Can end up with a too small CUE.
Size cooling provision for stator tube at duty point with lowest flow rate.	Flow min. m/s along the stator housing must be considered.
Ensure that the pump is used within the range of the pump curve.	Focus on discharge pressure and sufficient NPSH, as vibrations will "kill" the motor.

MP 204 motor protector

The MP 204 is an electronic motor protector, designed for the protection of an asynchronous motor or a pump. The MP 204 cannot be used in installations where a frequency converter is installed.

If one or more of the warning limits are exceeded, the motor continues to run, but the warnings will appear in the MP 204 display.

Some values only have a warning limit.

The warning can also be read out with the Grundfos R100 remote control.

If one of the trip limits is exceeded, the trip relay will stop the motor. At the same time, the signal relay is operating to indicate that the limit has been exceeded.

Applications

The MP 204 can be used as a stand-alone motor protector.

The MP 204 can be monitored via a Grundfos GENibus.

The MP 204 protects the motor primarily by measuring the motor current by means of a true RMS measurement.

The MP 204 is designed for single- and three-phase motors. In single-phase motors, the starting and run capacitors are also measured. $\cos \phi$ is measured in both single- and three-phase systems.

Benefits

The MP 204 offers these benefits:

- suitable for both single- and three-phase motors
- dry-running protection
- overload protection
- very high accuracy
- made for submersible pumps.

The MP 204, many monitoring options

The MP 204 monitors the following parameters:

- insulation resistance before start-up
- temperature (Tempcon, Pt sensor and PTC/thermal switch)
- overload/underload
- overvoltage/undervoltage
- phase sequence
- phase failure
- power factor
- power consumption
- harmonic distortion
- operating hours and number of starts.



Fig. 14 MP 204

Five sizes of single-turn transformers, 120-999 A.

Note: Monitoring of motor temperature is not possible when single-turn transformers are used.



Fig. 15 Single-turn transformers

Product numbers

Product	Product number
MP 204	96079927
R100	625333

TM03 1471 2205

TM03 2033 3505

Functions

- phase-sequence monitoring
- indication of current or temperature (user selection)
- indication of temperature in °C or °F (user selection)
- 4-digit, 7-segment display
- setting and status reading with the R100
- setting and status reading via the GENIbus.

Tripping conditions

- overload
- underload (dry running)
- temperature (Tempcon sensor, PTC/thermal switch and Pt sensor)
- phase failure
- phase sequence
- overvoltage
- undervoltage
- power factor (cos φ)
- current unbalance.

Warnings

- overload
 - underload
 - temperature (Tempcon and Pt sensor)
 - overvoltage
 - undervoltage
 - power factor (cos φ)
- Note:** In connection with single- and three-phase connection.
- run capacitor (single-phase operation)
 - starting capacitor (single-phase operation)
 - loss of communication in network
 - harmonic distortion.

Learning function

- phase sequence (three-phase operation)
- run capacitor (single-phase operation)
- starting capacitor (single-phase operation)
- identification and measurement of Pt100/Pt1000 sensor circuit.

External current transformers

When fitted with external current transformers, the MP 204 can handle currents from 120 to 999 A. Grundfos can supply approved current transformers from stock (200/5 A, 300/5 A, 500/5 A, 750/5 A, 1000/5 A).

Technical data, MP 204

Enclosure class	IP20
Ambient temperature	-20 to 60 °C
Relative air humidity	99 %
Voltage range	100-480 VAC
Current range	3-999 A
Frequency	50 to 60 Hz
IEC trip class	1-45
Special Grundfos trip class	0.1 to 30 s
Voltage variation	- 25 %/+ 15 % of rated voltage
Approvals	EN 60947, EN 60335, UL/CSA 508
Marking	CE, cUL, C-tick
Consumption	Max. 5 W
Plastic type	Black PC / ABS

	Measuring range	Accuracy [%]	Resolution
Current without external current transformers	3-120 A	± 1	0.1 A
Current with external current transformers	120-999 A	± 1	1 A
Phase-to-phase voltage	80-610 VAC	± 1	1 V
Frequency	47-63 Hz	± 1	0.5 Hz
Power	0-1 MW	± 2	1 W
Power factor	0 - 0.99	± 2	0.01
Energy consumption	0-4 x 10 ⁹ kWh	± 5	1 kWh

IO 112	Description	Product number
	<p>The IO 112 is a measuring module and a single-channel protection unit for use in connection with the MP 204 motor protector. The module can be used for protection of the pump against other factors than the electrical conditions, for instance dry running. It can also be used as a stand-alone protection module.</p>	96651601
	<p>The IO 112 interface has three inputs for measured values, one potentiometer for setting of limits and indicator lights indicating the following:</p> <ul style="list-style-type: none"> • measured value of the input • value of the limit set • alarm source • pump status. 	
<p>Electrical data</p> <ul style="list-style-type: none"> • Supply voltage: 24 VAC ± 10 %, 50/60 Hz or 24 VDC ± 10 %. • Supply current: Min. 2.4 A, max. 8 A. • Power consumption: Max. 5 W. • Ambient temperature: -25 to 65 °C. • Enclosure class: IP20. 		

TM03 58 11 3906

G100 gateway

The G100 gateway is used for communication with Grundfos products.

The G100 offers a wide selection of options for integration of Grundfos products provided with GENibus interface into main control and monitoring systems.

The G100 enables a pump installation to meet future demands for optimum pump operation in terms of reliability, operating costs, centralisation and automation.



Fig. 16 G100

GR5940

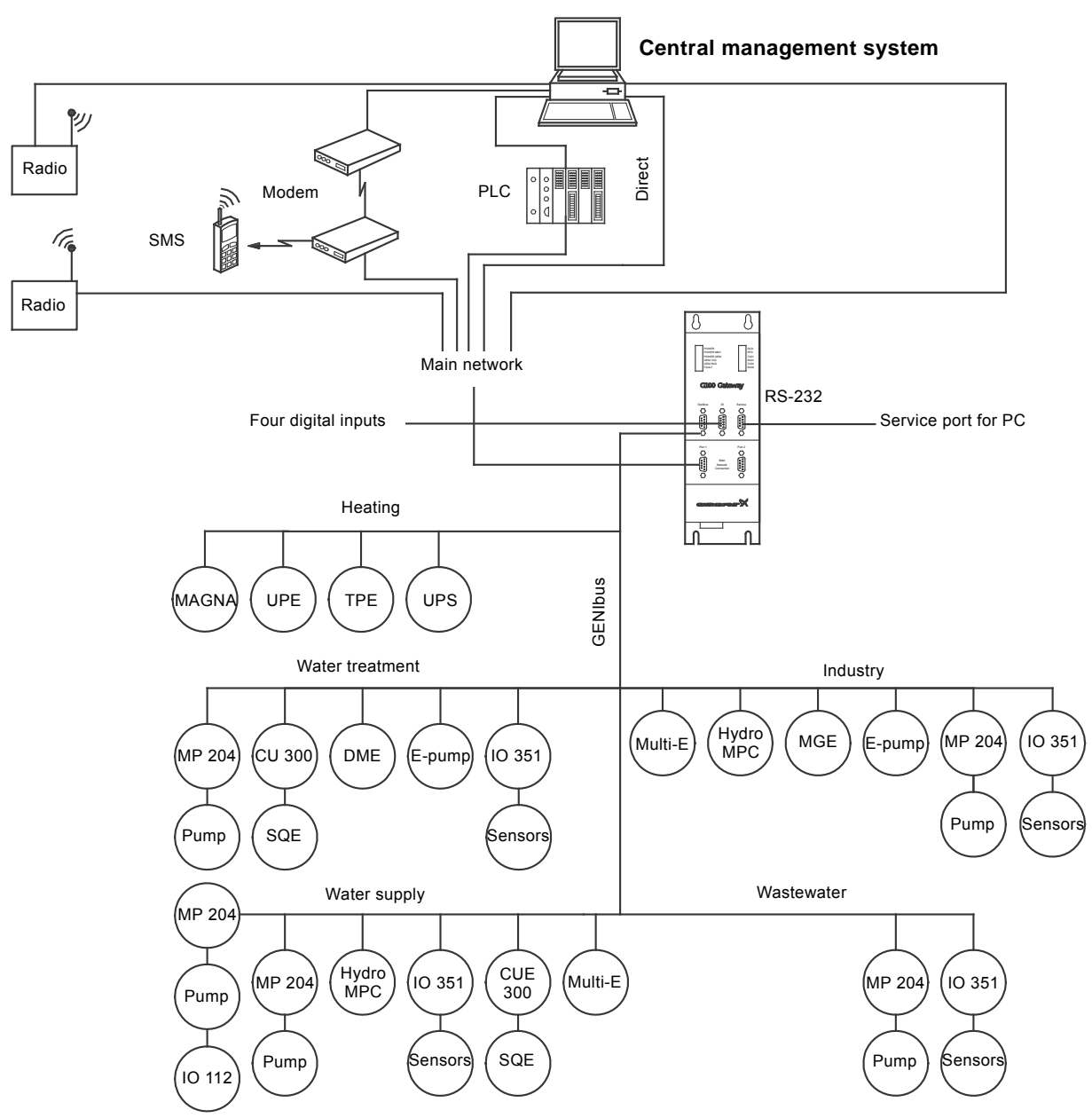

Fig. 17 Examples of G100 applications

TM03 9224 3607

Product description

The G100 gateway enables communication of operating data, such as measured values and setpoints, between Grundfos products with GENIbus interface and a main network for control and monitoring.

As indicated in the illustration on page 76, the G100 is suitable for use in applications such as water supply, water treatment, wastewater services, building automation and industry.

Common to the above applications is that downtime is usually costly, and extra investments are therefore often made to achieve maximum reliability by monitoring selected operating variables.

The day-to-day operation, such as starting and stopping of pumps and changing of setpoints, can also be effected from the main system by communication with the G100. In addition, the G100 can be set up to send event-controlled status indications such as alarms via SMS to mobile phones, and to make automatic alarm call-backs to a central management system.

Data logging

Besides data communication, the G100 offers logging of up to 350,000 time-stamped data. The logged data can be transmitted to the main system or a PC for further analysis in a spreadsheet or similar program. For the data logging, the "PC Tool G100 Data Log" software tool is used. The tool is part of the PC Tool G100 package supplied with the G100.

Other features

- four digital inputs
- stop of all pumps in case of failing communication with the management system (optional)
- access code for modem communication (optional)
- alarm log.

Installation

Installation of the G100 is carried out by the system integrator. The G100 is connected to the GENIbus as well as to the main network. All units on the GENIbus can thus be controlled from a central management system on the main network.

The "G100 Support Files" CD-ROM supplied with the G100 contains examples of programs to be used when the G100 is connected to the various main network systems. Included is also a description of the data points available in Grundfos products with GENIbus interface.

The "PC Tool G100" software tool included can be used for the installation and use of the G100.

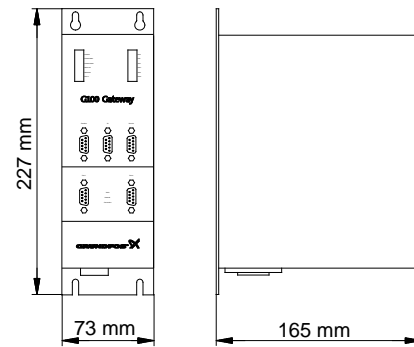

Fig. 18 Dimensional sketch

TM01 0621 1102

Technical data

Overview of protocols

Main system	Software protocol
Profibus-DP	DP
Radio	Satt Control COMLI/Modbus
Modem	Satt Control COMLI/Modbus
PLC	Satt Control COMLI/Modbus
GSM mobile phone	SMS, UCP

Other possible connections

- GENIbus RS-485: Connection of up to 32 units.
 Service port RS-232: For direct connection to a PC or via radio modem.
- Digital inputs: 4.
 Supply voltage: 1 x 110-240 V, 50/60 Hz.
 Ambient temperature: In operation: -20 to 60 °C.
 Enclosure class: IP20.
 Weight: 1.8 kg.

Accessories







- PC Tool G100 package (supplied with the product)
- G100 Support Files CD-ROM (supplied with the product).

Product numbers







Product	Product number
G100 with Profibus-DP expansion board*	96411135
G100 with Radio/Modem/PLC expansion board*	96411136
G100 Basic Version*	96411137
PC Tool G100 package	96415783

* CD-ROM with G100 Support Files included.



BM 4"

Parts	Description	Specification	Product number
	TM00 3702 0894 Victaulic coupling liner for welding Ø42 x 30	N version	00100517
		R version	00100971
	TM00 3703 0894 Victaulic coupling liner with external thread R 1 1/4 x 100 mm/BSPT	N version	00100534
		R version	00100965
	TM00 3705 0894 Victaulic style 77 coupling Ø42 x 1 1/4"	NBR seal	00ID6786
		FKM seal	00ID6742
	TM00 3706 0894 Hook spanner for 4" sleeve		00105029
	TM00 3707 0894 Connecting kit for welding, straight	NBR seal	N version 00105563 R version 00105982
		FKM seal	N version 00105565 R version 00105981
		NBR seal	N version 00105564 R version 00105980
		FKM seal	N version 00105566 R version 00105979
	TM00 3708 0894 Connecting kit R 1 1/4"	NBR seal	N version 00105564 R version 00105980
		FKM seal	N version 00105566 R version 00105979
	TM00 3711 0894 180 ° bend for victaulic coupling Ø42 / 1 1/4" Centre distance: 165 mm / 6.5 inch Total height: 127 mm / 5.0 inch	R version	00155926



BM 6"

Parts	Description	Specification	Product number
	TM00 3709 0894 Victaulic coupling liner for welding Ø89 x 50 mm / 3" x 2"	N version	00150574
		R version	00140968
	TM00 3711 0894 180 ° bend for victaulic coupling Ø89 / 3" Centre distance: 300 mm / 11.8 inch Total height: 210 mm / 8.3 inch	N version	00155544
		R version	00155971
	TM00 3712 0894 Victaulic style 77 coupling Ø89 x 3"	NBR seal	00ID7664
	TM00 3713 0894 Hook spanner for 6" sleeve		00ID7669
	TM00 3714 0894 Connecting kit for welding, straight	NBR seal N version	00155542
		NBR seal R version	00155973
	TM00 3715 0894 Connecting kit, 180 °	NBR seal N version	00155543
		NBR seal R version	00155972

BM 8"

Parts	Description	Specification	Product number
	TM00 3712 0894 Victaulic style 77 coupling 3": Ø89 4": Ø114 5": Ø139 6": Ø168	NBR seal 3"	00ID7664
		NBR seal 4"	96415463
		NBR seal 5"	96416739
		NBR seal 6"	00ID2279
	TM00 3709 0894 Victaulic coupling liner for welding	N version 3"	00150574
		N version 4"	96416743
		N version 5"	96416744
		N version 6"	96416745

BMhp

Parts	Description	Specification	Product number
	TM00 3712 0894 Victaulic coupling 3": Ø89 4": Ø114 5": Ø139 6": Ø168	NBR seal 3", style 77S	97758517
		NBR seal 4", style 77S	97758346
		NBR seal 5", style 489	97758342
		NBR seal 6", style 77S	97758320
	TM00 3709 0894 Victaulic coupling liner for welding	R version 3"	00140968
		R version 4"	96986570
		R version 5"	96785838
		R version 6"	96230662

14. Customising your pump

Custom-made pumps

Although the Grundfos BM product range offers a number of pumps for different applications, customers require specific pump solutions to satisfy their needs.

Below is listed a range of options for customising the BM pumps to meet the customers' demands.

Contact Grundfos for further information or other requests than the ones mentioned below.

Available on request

Materials

Pump range	DIN	AISI
BM 3A - BM 215	1.4301	304
BM 9 - BM 215	1.4539	904L

Flange adapters

Flange type	Function	Materials
DIN flange	Grundfos DIN flange adapter for connection to counter DIN flange	N versions 3", 4", 5" and 6"
JIS flange	Grundfos JIS flange adapter for connection to counter JIS flange	N versions 3", 4", 5" and 6"
---	Custom-made flange adapter for connection to counter flange	N versions 3", 4", 5" and 6"

Motors

Other motors than the ones of the standard range are available on request:

- rewindable motors
- Industrial motors
- 6" motors for liquid temperatures up to 90 °C
- 8" motors for liquid temperatures up to 75 °C.

15. Grundfos Product Center

Online search and sizing tool to help you make the right choice.

<http://product-selection.grundfos.com>



SIZING enables you to size a pump based on entered data and selection choices.

REPLACEMENT enables you to find a replacement product. Search results will include information on

- the lowest purchase price
- the lowest energy consumption
- the lowest total life cycle cost.

The screenshot shows the Grundfos Product Center website. At the top, there is a navigation bar with the logo and links for HOME, FIND PRODUCT, COMPARE, YOUR PROJECTS, SAVED ITEMS, and HELP. Below this is a search bar with a 'SEARCH' button. The main content area features four large buttons: SIZING (Enter pump sizing), CATALOGUE (Products and services), REPLACEMENT (Replace an old pump with a new), and LIQUIDS (Find pump by liquid). Below these buttons is the 'QUICK SIZING' section, which includes input fields for 'Enter duty point' (Flow (Q)* and Head (H)*) and 'Select what to size by' (Size by application, Size by pump design, Size by pump family). A 'START SIZING' button is located to the right of the selection options. At the bottom of the quick sizing section, there are links for 'ADVANCED SIZING' with options for 'Advanced sizing by application' and 'Guided selection'.

CATALOGUE gives you access to the Grundfos product catalogue.

LIQUIDS enables you to find pumps designed for aggressive, flammable or other special liquids.

All the information you need in one place

Performance curves, technical specifications, pictures, dimensional drawings, motor curves, wiring diagrams, spare parts, service kits, 3D drawings, documents, system parts. The Product Center displays any recent and saved items - including complete projects - right on the main page.

Downloads

On the product pages, you can download installation and operating instructions, data booklets, service instructions, etc. in PDF format.

Subject to alterations.

V7081496 0115
ECM: 1150511

GRUNDFOS A/S
DK-8850 Bjerringbro . Denmark
Telephone: +45 87 50 14 00
www.grundfos.com

DYSTRYBUTOR
Valmark Sp. z o.o.
tel: (22) 868 58 58
mail: biuro@valmark.pl

GRUNDFOS 